

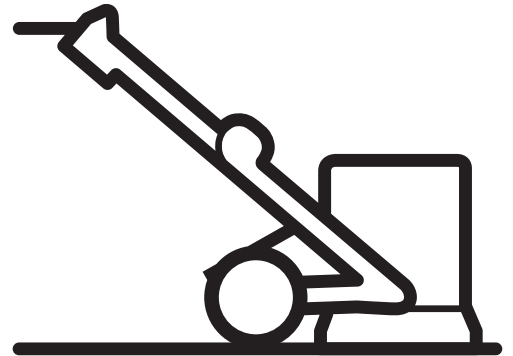

Husqvarna®



HTC T6/RT6/X6/RX6

Husqvarna, 2020-12-11

Operator's manual, EN

Dear customer,

Thank you for choosing a Husqvarna quality product. We hope that you will genuinely enjoy it.

Please note that the enclosed manual contains HTC Floor Systems references.

The Husqvarna Group is vouching for the quality of this product.

If you have any questions, please do not hesitate to contact our local sales or service point, or visit www.husqvarnacp.com.

Husqvarna AB

SE-561 82 Huskvarna, Sweden



EC Declaration of Conformity

We, **Husqvarna AB**, SE 561 82 Huskvarna, SWEDEN, Tel. +46 36 146500 declare on our sole responsibility that the product:

Description	Polish & Grind Equipment
Brand	HUSQVARNA
Type / Model	HTC T6, HTC X6
Identification	Serial numbers dating from 2020 and onwards

complies fully with the following EU directives and regulations:

Directive/Regulation	Description
2006/42/EC	"relating to machinery"
2014/30/EU	"relating to electromagnetic compatibility"
2011/65/EU	"relating to restriction of hazardous substances"

and that the following standards and/or technical specifications are applied;

EN 60335-1:2012/A11:2014/AC:2014

EN 60335-2-72:2012

EN 61000-6-2:2005 + AC :2005

EN 61000-6-4:2007+A1:2011

Partille, 2020-10-16



Martin Huber

R&D Director, Concrete Surfaces & Floors
Husqvarna AB, Construction Division

Responsible for technical documentation

EC Declaration of Conformity

We, **Husqvarna AB**, SE 561 82 Huskvarna, SWEDEN, Tel. +46 36 146500 declare on our sole responsibility that the product:

Description	Polish & Grind Equipment
Brand	HUSQVARNA
Type / Model	HTC RT6, HTC RX6
Identification	Serial numbers dating from 2020 and onwards

complies fully with the following EU directives and regulations:

Directive/Regulation	Description
2006/42/EC	"relating to machinery"
2014/53/EU	"relating to radio equipment"
2011/65/EU	"relating to restriction of hazardous substances"

and that harmonized standards and/or technical specifications are applied as follows;

EN 60335-1:2012/A11:2014/AC:2014

EN 60335-2-72:2012

EN IEC 61000-6-2:2005 + AC:2005

EN 61000-6-4:2007+A1:2011

ETSI EN 301 489-1 V2.2.0

ETSI EN 301 489-17 V3.2.0

ETSI EN 300 328 V2.1.1

Partille, 2020-10-16



Martin Huber

R&D Director, Concrete Surfaces & Floors
Husqvarna AB, Construction Division

Responsible for technical documentation

Standards

As the manufacturer, we hereby declare under our sole responsibility that the above product with serial numbers from 2016 onward conforms to the applicable regulations in:

EN 60335-1:2012	Household and similar electrical appliances - Safety - Part 1: General requirements.
EN 60335-1:2012 + A11:2014	Household and similar electrical appliances - Safety - Part 1: General requirements.
EN 60335-2-72:2012	Household and similar electrical appliances - Safety - Part 2-72: Particular requirements for floor treatment machines with or without traction drive, for commercial use.
EN 62233:2008	Measurement methods for electromagnetic fields of household appliances and similar apparatus with regard to human exposure.
EN 61000-6-4:2007 + A1:2001	EMC
FCC CFR 47 Part 15 (2016)	EMC
EN 61000-6-2 (2005)	EMC
DIRECTIVE 2006/42/EC	Machinery directive.
DIRECTIVE 2014/30/EC	EMC
DIRECTIVE 2014/35/EC	LVD

ISO 5349-1:2001	Mechanical vibration -- Measurement and evaluation of human exposure to hand-transmitted vibration -- Part 1: General requirements.
ISO 5349-2:2001	Mechanical vibration -- Measurement and evaluation of human exposure to hand-transmitted vibration -- Part 2: Practical guidance for measurement at the workplace.
ISO 20643:2005	Mechanical vibration -- Hand-held and hand-guided machinery -- Principles for evaluation of vibration emission.
ISO 3744:2010	Acoustics -- Determination of sound power levels and sound energy levels of noise sources using sound pressure -- Precision methods for reverberation test rooms.
ISO 11201:2010	Acoustics -- Noise emitted by machinery and equipment -- Determination of emission sound pressure levels at a work station and at other specified positions applying approximate environmental corrections.

The product was CE marked in 2016. The technical documentation is available from the manufacturer.

Table of contents

1	Introduction.....	9
1.1	General.....	9
1.2	Liability.....	9
1.3	Warranty	9
2	Safety.....	10
2.1	Symbols that are used.....	10
2.2	Safety rules.....	10
3	Information about the machine	13
3.1	Unpacking the equipment.....	13
3.2	Transport	13
3.2.1	Transport	13
3.2.2	Lifting.....	13
3.2.3	Movement.....	13
3.2.4	Hanging the cover	15
3.2.5	Support wheel	16
3.3	Storage.....	16
3.4	Machine name plate	17
3.5	Hand and arm vibrations	18
3.6	Sound power level	18
4	Machine description.....	19
4.1	General machine description.....	19
4.2	Storage compartment.....	22
4.3	Control cabinet	24
4.4	Description of Controls – Control Panel (HMI)	25
4.5	Information Panel	27
4.6	Connection Panel	30
5	Operation.....	31
5.1	General.....	31
5.2	Handle setting.....	31
5.3	Handling weights	33
5.4	Cable and Hose Strain Relief Device	35
5.5	Access to Grinding Tools	35
5.6	Fitting Grinding Tools.....	36
6	Grinding	38
6.1	Manoeuvring via the Control Panel	38
6.1.1	Manual Driving	39
6.1.2	Emergency Stop Switch	39
6.2	Making Operation Easier	40
7	Accessories	41
7.1	Radio package.....	41
7.1.1	Description of Controls – Remote Control.....	41
7.1.2	Radio Receiver	44
7.1.3	Charging	45
7.1.4	Operation.....	45
7.1.5	Locking the Wheels	46

7.2	Radio Control.....	47
7.3	GPS Tracker	48
7.3.1	Start Up	48
7.3.2	Registration	49
7.3.3	Use	49
7.3.4	GSM card	50
7.3.5	Remote Control	50
7.4	Water package.....	51
7.4.1	Mist Cooler System	51
7.4.2	Wet grinding	52
8	Maintenance and repair	54
8.1	General.....	54
8.2	Cleaning	54
8.3	Prior to each new grinding process	55
8.4	Daily.....	55
8.5	Every week.....	55
8.6	Repairs	55
8.7	Spare parts.....	56
8.8	Warranty	56
9	Troubleshooting.....	57
9.1	General.....	57
9.2	The machine will not start	57
9.3	Fuse or earth fault breaker trip frequently	58
9.4	The machine cannot cope	58
9.5	Warnings and Error Messages	59
9.5.1	Warnings	59
9.5.2	Error Messages	61
10	Technical Data	63
11	Environment.....	73
11.1	Chassis.....	73
11.2	Grinding head.....	73
11.3	Electrical system	74
11.4	Recycling.....	74

1 Introduction

1.1 General

HTC's machines are used for processing floor surfaces. The machine's area of application depends on the choice of tool.

In addition to use and general functions, this manual explains the applications and maintenance of your HTC machine. Contact your local retailer for further information. For contact information, see the start of the manual.

1.2 Liability

Even though every effort has been made to make this manual as complete and accurate as possible, we bear no responsibility for incorrect or missing information. HTC reserves the right to change descriptions in this manual without giving prior notice.

This manual is protected by the Copyright Act and no part of it may be copied or used in any other way without the written approval of HTC.

1.3 Warranty

This warranty only covers manufacturing defects. HTC bears no responsibility for damage that arises or occurs during transportation, unpacking or use. In no instance and under no circumstances shall the manufacturer be held responsible for damage and defects caused by incorrect use, corrosion or use outside the prescribed specifications. The manufacturer is not responsible for indirect damage or costs under any circumstances. For complete information on the manufacturer's warranty period, see HTC's current warranty terms.

Local distributors may have special warranty terms specified in their terms of sale, delivery and warranty. If there is any uncertainty regarding warranty terms, please contact your retailer.

2 Safety

This chapter includes the safety rules that must be observed when using HTC's machines.

2.1 Symbols that are used

The symbols below are used in this manual to show the need for extra care when using the machine.



WARNING

This symbol means **Warning!** and indicates a risk of personal injury or material damage.

If the warning is not observed, this could result in death or serious personal injury.



NOTE

This symbol means **Note!** and indicates a risk of material damage in the event of incorrect use.



TIP

This symbol means **Tips!** and indicates tips and advice on effective use of the machine or ways of reducing wear and tear to the machine.

2.2 Safety rules

Users of machines from HTC have the ultimate responsibility for ensuring that everybody who works with or in the vicinity of the equipment follow all applicable safety rules. Safety measures must meet the requirements that apply for this type of equipment. Apart from the standard rules that apply in the workplace, the recommendations in this manual shall also be observed.

All work must be performed by trained personnel. Users of machines from HTC must have read through the dedicated manual for the machine. Incorrect use of the equipment could result in situations that could cause harm to the operator, the surroundings or the machine.

**WARNING**

Training is required.

Risk for personal injury and mechanical damage.

Children should be kept under supervision to prevent them from playing with the machine.

The machine must not be operated by children or in the vicinity of children. The machine must not be used by those with impaired physical, sensory or mental abilities or by those who lack the knowledge that is required for using the machine.

Machines from HTC may only be used in the way recommended by HTC.

Machines from HTC may only be used for commercial purposes.

Anyone using the machine shall know about:

- its functions
- location of emergency stops
- the safety rules for the work

The operator shall ensure that:

- No unauthorised person is stationed within the work area when the machine is started up

The workplace shall:

- be suitable for the purpose
- be secured from loose objects that can be thrown out by the machine
- be free from protruding bolts etc. on the surface to be processed

Individuals in the workplace shall always use the recommended personal protective equipment and wear suitable clothing:

- safety goggles
- protective gloves
- steel toe safety shoes
- hearing protection
- respiratory mask
- do not wear loose fitting clothing or anything that can catch, such as scarves, bracelets, rings, etc.

General precautions:

- Check the machine is connected to an earthed wall socket.
- Work on live parts shall only be performed by qualified personnel.
- Suitable fire extinguishers shall be clearly marked and close to hand.
- Maintenance of the equipment must not be performed during operation.

The machine is only tested for use up to 2000 metres above sea level.



	<p>⚠ DANGER</p> <p>HIGH VOLTAGE Disconnect power before servicing.</p>
	<p>⚠ WARNING</p> <p>To reduce the risk of fire, use only commercially available floor cleaners and waxes intended for machine application.</p>
	<p>⚠ WARNING</p> <p>Risk of explosion. Floor sanding can result in an explosive mixture of fine dust and air. Use floor sanding machine only in well ventilated area.</p>
	<p>⚠ CAUTION</p> <p>Moving Parts – To reduce the risk of injury, unplug before servicing.</p>

G003338

This information decal is affixed clearly visible on the machine's electrical cabinet.

3 Information about the machine

3.1 Unpacking the equipment

Check the packaging and equipment carefully on delivery for any possible transport damage. If there is any sign of damage, contact the retailer and report the damage. Report packaging damage to the transport company as well.

Check that the delivery matches the order. If there are any questions, contact the retailer.

3.2 Transport



WARNING

Risk for personal injury and mechanical damage



NOTE

During moving, transport and lifting, the weights shall be in position 1, see Handling Weights.

3.2.1 Transport

Always make sure that the machine is securely anchored to its surroundings and that the grinding head is lowered on to the surface. Tighten the securing straps, or other equipment used for anchoring during transport over non-moving parts, e.g. the machine's chassis.

3.2.2 Lifting

The machine can also be lifted using the lifting eyes provided or using other approved lifting equipment. In which case, make sure that the weights are locked in the forward position and that the handle is in its back position, see Handling weights page 33 and Handle setting page 31. When lifting the machine, lifting straps must be used.

3.2.3 Movement

When moving on sloping surfaces, e.g. loading ramps, the machine should be secured in the lifting eyes, for example, using a winch. This is a safety measure in case the machine starts to roll out of control or tip over. The weights should be in position 1, see Handling weights page 33. Otherwise, there is a risk that the machine tips backwards. Ensure there is no one below the machine during movement on sloping surfaces.



G003256

Fixing points for lifting and securing.

3.2.4 Hanging the cover

During transport or work with HTC grouting, the cover can be hung up so it does not drag on the surface.

Lift up the cover and secure it with the rubber straps to secure the cover in the raised position.



WARNING

Moving parts. High noise level.

Risk for personal injury.

Always use the recommended personal protective equipment.

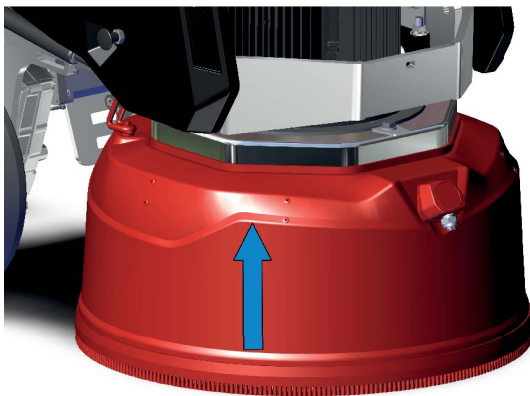

G003166

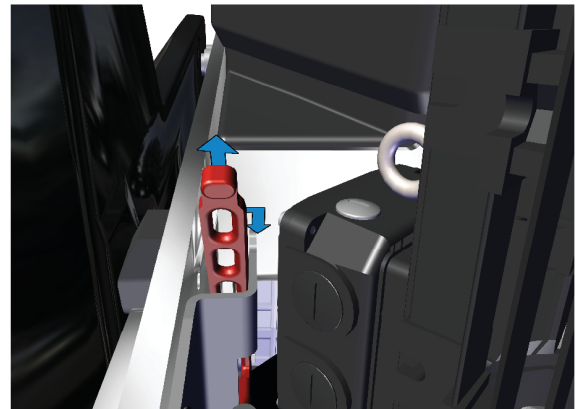

G003104



G003105



G003167

3.2.5 Support wheel



G003412

To ease movement, a support wheel can be firmly mounted on the machine.



G003413

The support wheel can be mounted during grinding.

3.3 Storage

The machine should be stored in a heated, dry area when not in use. It may be damaged by condensation and cold.

3.4 Machine name plate

The machine name plate provides the following information. The model and serial number must be specified when ordering spare parts for the machine.

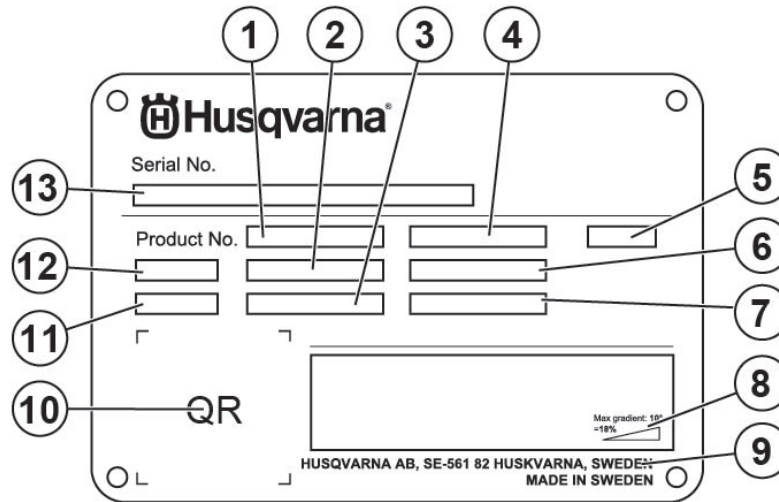

1. Product number
2. Product weight
3. Rated power
4. Rated voltage
5. Enclosure
6. Rated current
7. Frequency
8. Maximum slope angle
9. Manufacturer
10. Scannable code
11. Production year
12. Model
13. Serial number

3.5 Hand and arm vibrations

Hand and arm-weighted vibration levels [m/s²] for HTC T6/RT6/X6/RX6 have been measured using equipment approved in accordance with ISO 5349-1:2001. The uncertainty of measurement for the measuring equipment is given as $\pm 2\%$.

The machine has been tested in accordance with ISO 5349-2:2001 and ISO 20643:2005 in order to identify the operations that contribute to the most frequent vibration exposures. At vibration levels > 2.5 m/s² the exposure time should be limited in accordance with the table below. For vibration levels > 5 m/s² immediate measures must be taken by the employer to ensure that the exposure time does not exceed the time specified in the table below.

Identified work conditions	Measured values [m/s ²]	Daily permitted exposure (number of hours)
Grinding/polishing	< 2.5 m/s ²	> 10 h

3.6 Sound power level

This machine has been tested for noise in accordance with ISO 3744:2010 and ISO 11201. Measured using class 1 instruments as sound level meters. For information about sound level power, see chapter Technical Data page [63](#).

4 Machine description

4.1 General machine description

A grinding machine from HTC has been developed for processing various types of floor. It is used to grind, coarse grind, prepare and polish concrete, natural stone and terrazzo floors or other materials specified in this manual or material recommended by HTC.

Some grinding machines can be equipped with radio control. Radio control is an accessory that eases the work considerably.

The machine is constructed from a number of main components, see below page 20.

The handle can be set in a number of different tilt positions. Choose a position that suits you best, when the machinery is to be operated manually.

The machine's grinding head can be equipped with one of several different grinding discs that are covered by a sealed sloping cover against the floor. The cover together with the connected vacuum system provide the conditions needed for a good work environment. The cover ensures that the operator does not come into contact with rotating mechanical parts and exposure to dust is minimised. Because the cover is floating, the dust uptake is optimised since it is always in contact with the surface.

Always make sure that a dust extractor is connected to the grinder during dry grinding to prevent as far as possible exposure to dust particles of operators, people in the vicinity, the grinder and other equipment.



WARNING

Dust.

Risk for personal injury.

The dust that is sucked up may be harmful if inhaled. Follow local regulations and use breathing protection.

The machine can be easily equipped with a large number of tools, depending on the floor material to be ground. For more information about different tools, see HTC's website www.htc-floorsystems.com.

Some grinding machines can be equipped with a Mist Cooler system for effective cooling of the grinding tools. This system enables a very fine water mist to be diffused through a nozzle over the floor surface, which cools the tools and thereby makes the grinding more effective.



G003218

No.	Description
1	Storage hatch
2	Handlebar locking rough adjustment
3	Storage hatch
4	Lifting point
5	Fixing point for support wheel and securing the load
6	Nozzle for Mist Cooler System
7	Handlebar
8	Handlebar locking fine adjustment
9	Service hatch
10	Weight handle
11	Weight
12	Weight locking
13	Grinding head
14	Wheel lock for driving

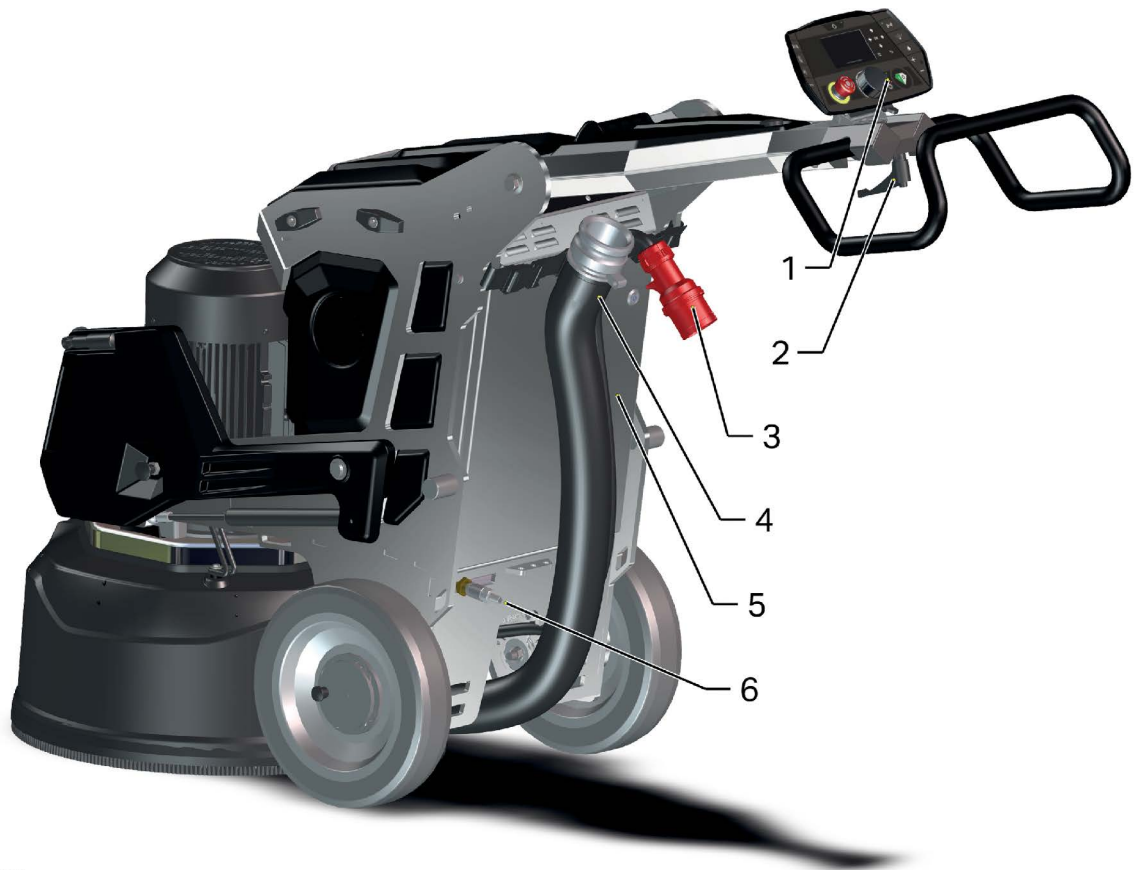

G003183

No.	Description
1	Control panel
2	Handle lock
3	Electrical connection
4	Connection, dust extractor
5	Control cabinet
6	Water quick release coupling

4.2 Storage compartment



G003264

No.	Description
1	Storage compartment
2	
3	Service hatches
4	

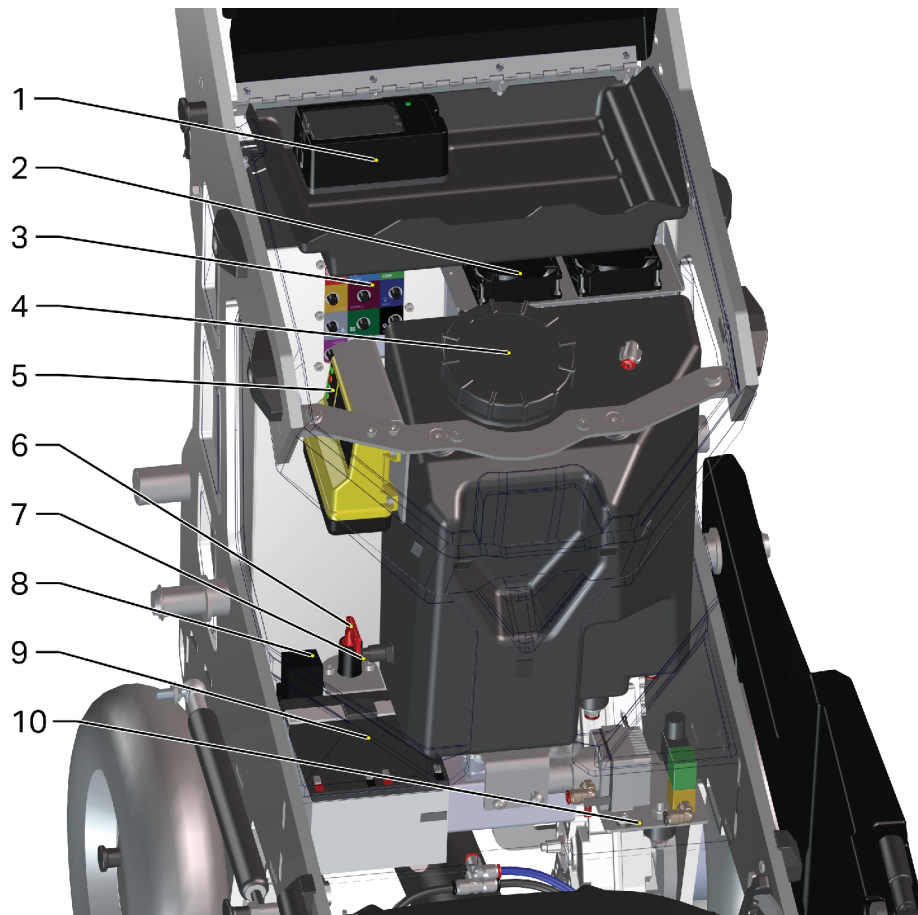

G003288

No.	Description	Accessories
1	Battery charger for remote control	Radio package
2	Cooling fans	
3	Connection panel for accessories	
4	Water tank	Water package
5	Radio receiver	Radio package
6	Battery disconnecter	Radio package
7	Water level sensor	Water package
8	Relay	Radio package
9	Battery	Radio package
10	Mist Cooler system pump / proportional valve water supply	Water package

4.3 Control cabinet

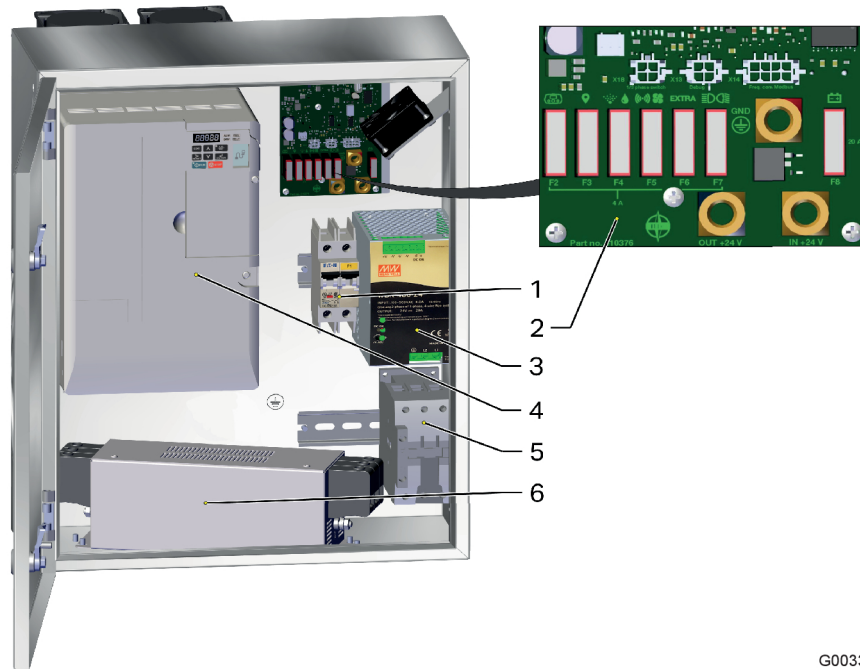

G003371

No.	Designation	Description
1	F1	Miniature circuit breakers 2 x 5A for Power Supply
2	Mainboard	
	F2	Fuse 4A, Control Panel
	F3	Fuse 4A, GPS
	F4	Fuse 4A, Water / Mist System
	F5	Fuse 4A, Radio / Cooling Fans,
	F6	Fuse 4A, Extra
	F7	Fuse 4A, Accessory
	F8	Main Fuse 20A, Control Voltage
3	U2	Power Supply
4	U1	Frequency Converter
5	K1	Contact
6	Z1	EMC Filter

4.4 Description of Controls – Control Panel (HMI)

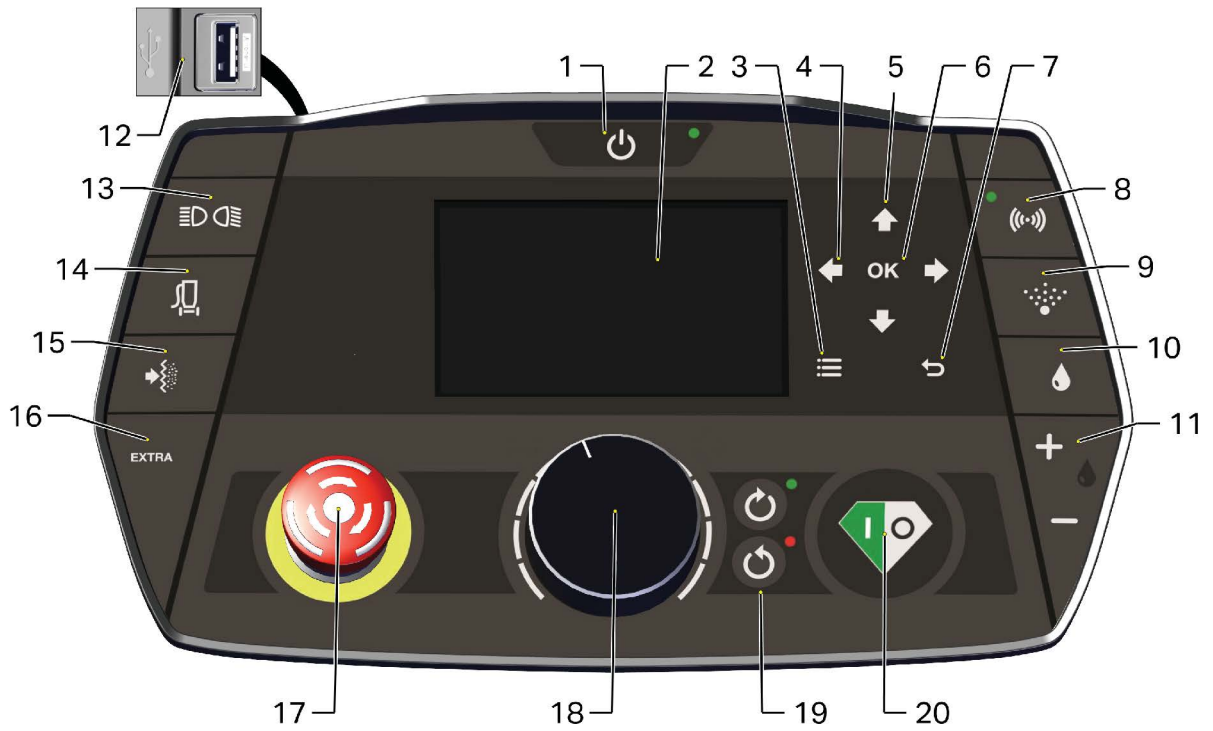







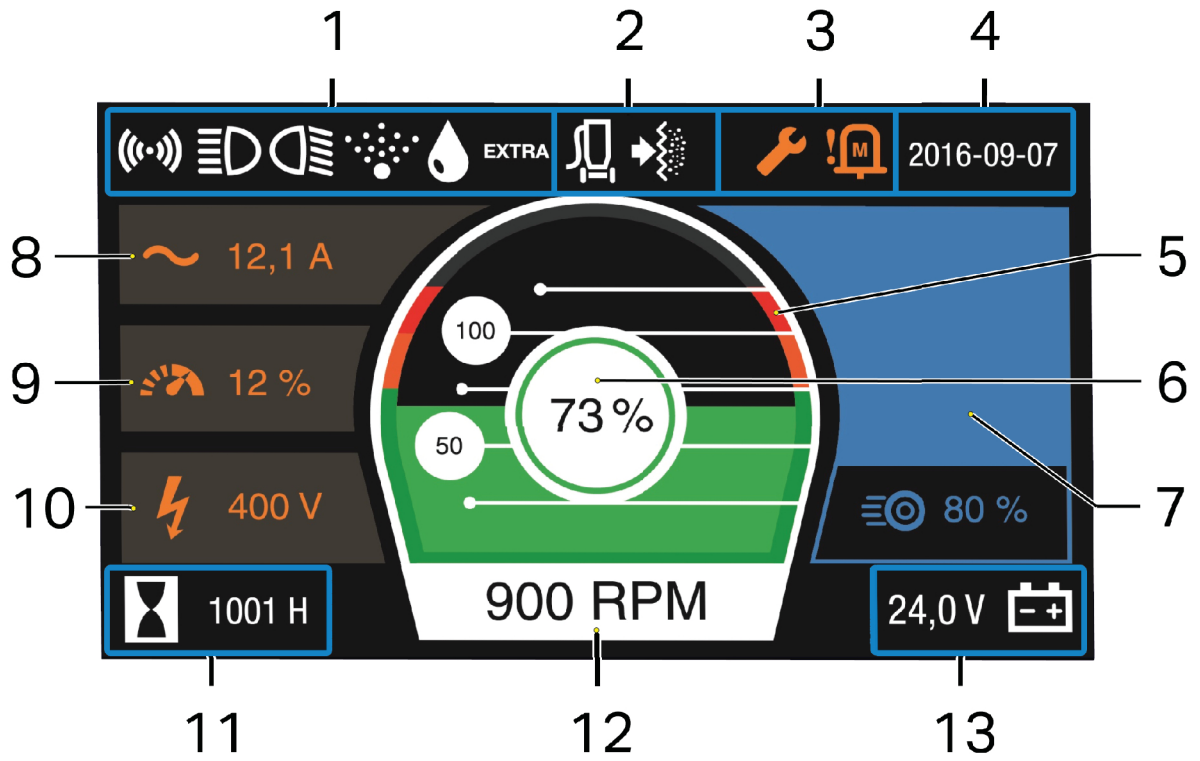



G003353



No.	Function	Description
1	On / Off	To start / stop the machine
2	Information Panel	See Information Panel page 27 .
3	Menu Buttons	Menu
4		Right / Left – Menu navigation as well as changing the operation gauge.
5		Up / Down – Menu navigation as well as Night Panel on/off.
6		OK – Menu navigation as well as zeroing the trip meter on long press.
7		Back
8	Radio Communication	On / Off
9	Mist Cooler System	On / Off
10	Water Supply	On / Off
11		Increase or Decrease
12	USB Port	E.g. Mobile phone charging
13	Accessories	See the instructions for accessories
14	Vacuum Clean Control	Future Options
15		
16	EXTRA	On / Off
17	Emergency stop	See Emergency Stop Switch page 39 .
18	Grinding Speed	Increase or decrease the grinding speed.
19	Grinding Direction	Clockwise / Anticlockwise.
20	Grinding	Start / Stop.

4.5 Information Panel



G003354











No.	Symbol	Name	Explanation
1		Radio	Lit when the machine is in radio mode. When in radio mode, only the Emergency Stop Button and the Radio Button on the machine's control panel function.
		Accessories	Lit when the accessory is activated.
		Accessories	Lit when the accessory is activated.
		Mist Cooler System	Lit when the Mist Cooler System is active. Colour changes to yellow when the water level in the tank is low.
		Water Supply	Lit when the water supply is active.
		Extra	Lit when the output Extra is active.
2		Vacuum Cleaner	Future selections
3		Service	Service shines orange 50 h or 2 weeks prior to service. Turns red once the service interval has been exceeded.
		Warning	Warning symbol is lit when warning or fault occurs. Symbol indicates type of fault.
4		Time	Shows time and date.
5		Power Meter – Available power	Show the amount of power available.
6		Power Meter – Power used	The level indicator and the ring around the value change colour depending on how much of the available power is being used. The ring is green when the grinding power is 0-100%, yellow 100-115% and red from 115%.
7		Water Flow / Propulsion Speed	Water Flow 0-100% / Propulsion Speed 0-15 m/min.
8		Current	Shows motor current.
9		Overload / Overload Protection	Overload indication, warns at 90%. The machine switches off at 100%.

No.	Symbol	Name	Explanation
10		Voltage	Shows the mains voltage.
11		Operation Gauge	Shows operating time h, distance m and energy kWh.
12		Grinding Speed	Shows the rotational speed of the grinding discs.
13		Control Voltage	Shows the machine's control voltage. Shows battery voltage when the machine is operated on batteries only.

4.6 Connection Panel



G003396

Symbol	Connection for
	Control panel
	Radio Receiver
	CAN bus
	Extra equipment, 24 V
	Extra 2. Used for future equipment
	Mist Cooler System
	Water supply valve
	Cooling fans
	GPS
	Accessories

5 Operation

5.1 General

The following section describes how to change tools and how to operate the grinding machine. This section does not deal with the technical aspects of grinding, such as selection of grinding tools, etc.

For choice of tool, go to HTC's website www.htc-floorsystems.com for more information.

5.2 Handle setting



WARNING

Risk of crushing.
Risk for personal injury.



NOTE

Ensure that the handle lock locks properly in the position wanted when adjusting the handle.

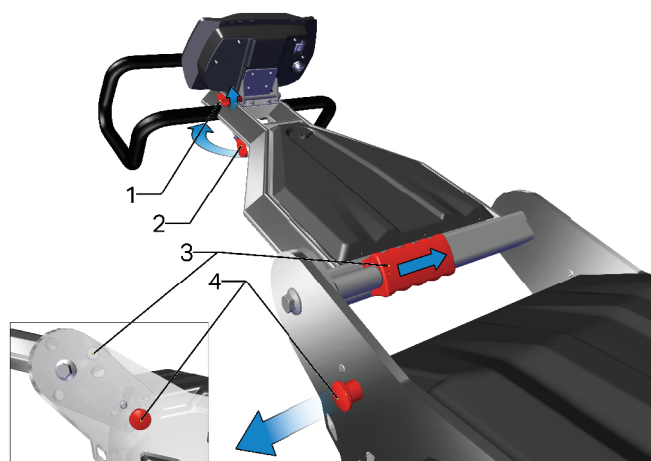

G003430

No.	Description
1	HMI adjustment
2	Handle adjustment
3	Handlebar rough adjustment
4	Handlebar fine adjustment

Place in the right working height using the various settings.

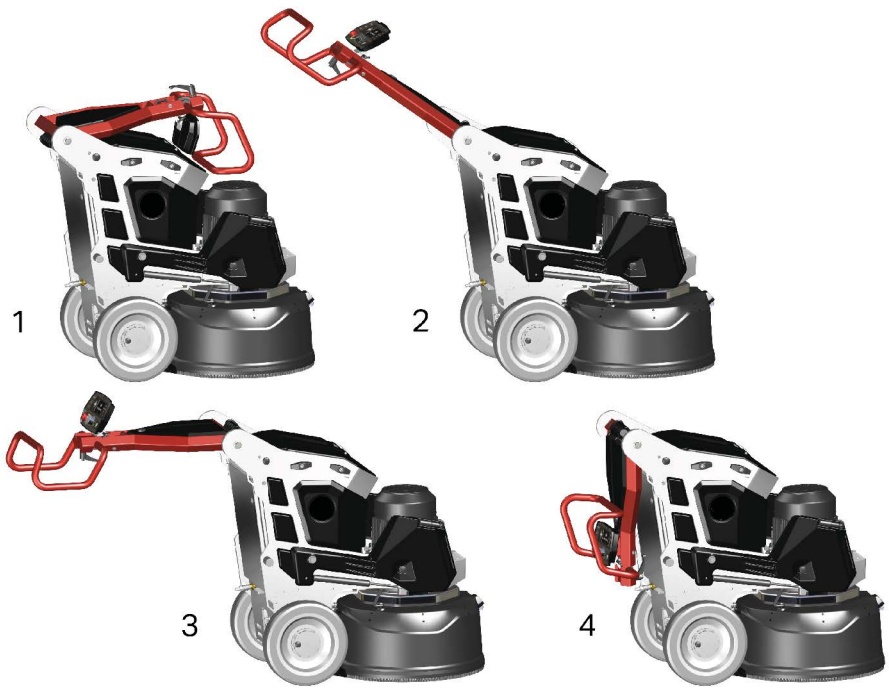

G003208

No.	Description
1	Handle position 1
2	Handle position 2
3	Handle position 3
4	Handle position 4

5.3 Handling weights

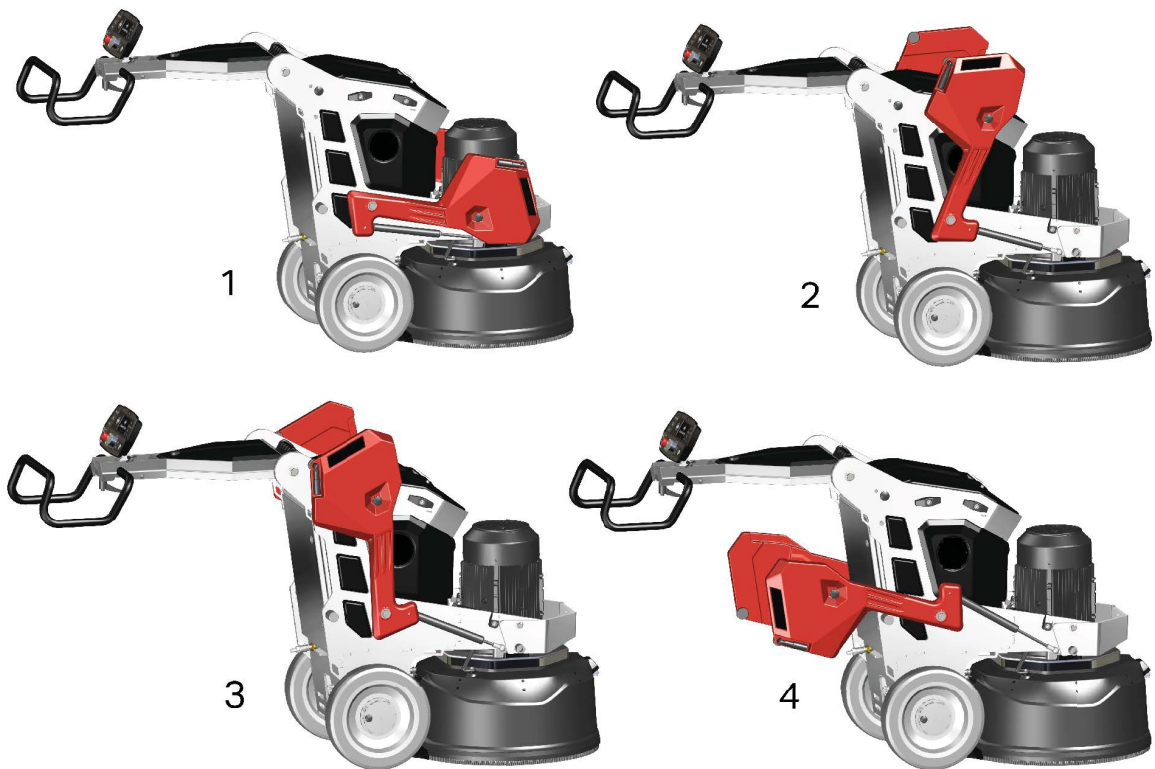

G003185

No.	Weights in the different positions
1	Weight position 1
2	Weight position 2
3	Weight position 3
4	Weight position 4

The machine is equipped with two weights to make it easy to move the machine's centre of gravity. Each weight is provided with a locking pin with which the weights can be lowered and locked into three positions as well as backwards.

- Pull the pin outwards and take hold of the handle and move the weight. Release the pin and it fastens in the next fixed position.

**WARNING**

Risk of crushing.

Risk for personal injury.

Ensure that the pin locks in the position wanted when adjusting the weights. Ensure that there is no gap at the sides when the weight is locked. Risk for the lock releasing.

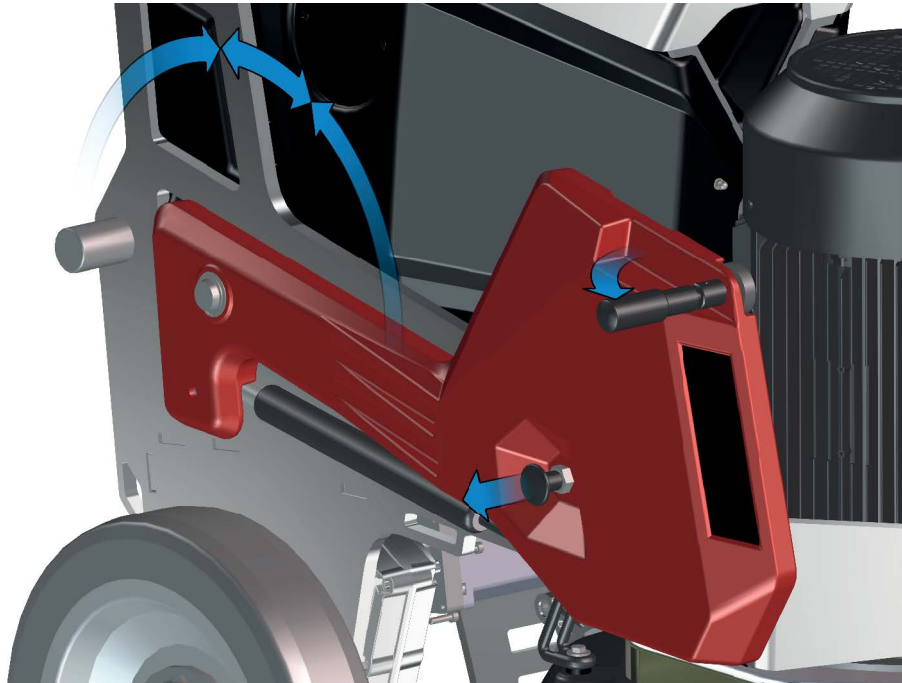
**TIP**

If the machine is heavy to operate, it may be due to the placing of the weights. Fold the weights up or back to unload the grinding head.

In order for the grinding pressure to be maximised, the weights shall be placed in position 1 and to be minimised in position 4, see page 33 and Technical Data.

If the machine feels heavy to operate, it may be due to the placing of the weights. Raise the weights to position 2, position 3 or position 4 to relieve the grinding head. Ensure that the weights are in the same position on both sides to prevent the risk of uneven grinding.

5.4 Cable and Hose Strain Relief Device

There are two alternative cable and hose strain relief devices on the machine. Use the one that is most suitable for the work situation in question. Ensure that the grinding cover is not affected by tension in the hose.



5.5 Access to Grinding Tools



WARNING

Risk of crushing.

Risk for personal injury and mechanical damage.

Disconnect the power prior to cleaning, maintenance, change of tools and repair.

Raise the handle to the third position in accordance with the Handle Settings page 32.

Lower the weights back and place a foot on one of the weights. See Handle Settings page 32.

The machine may be heavy. Using the fine adjustment makes it easier to adjust the settings, see Handle Settings page 32.

Carefully, tip the machine backwards, until the weights reach the floor.

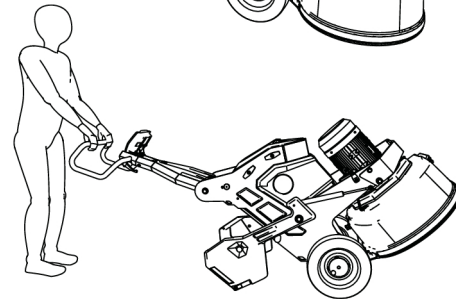
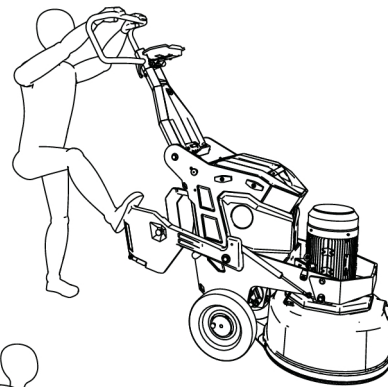

Tip the machine further back, until all of the machine reaches the floor.

Ensure that the machine lies supported on the handle.

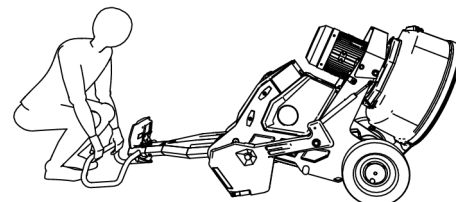

G003266

5.6 Fitting Grinding Tools



WARNING

High Temperature
Risk for Dust



NOTE

Note the direction of rotation of the grinding discs.

Slide the new grinding tool diagonally, from above, down into the appropriate guide slot on the tool holder. Then push the tool fully into the guide slot.

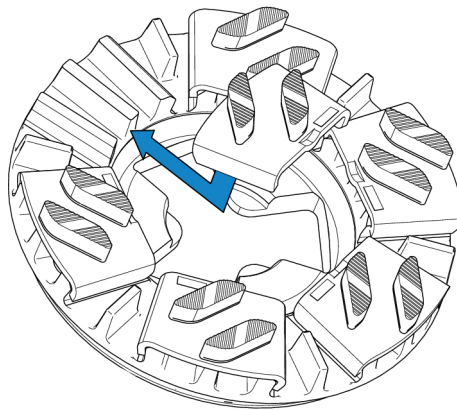

G003311

Lock the grinding tool into the tool holder by giving it a few light taps with a hammer.

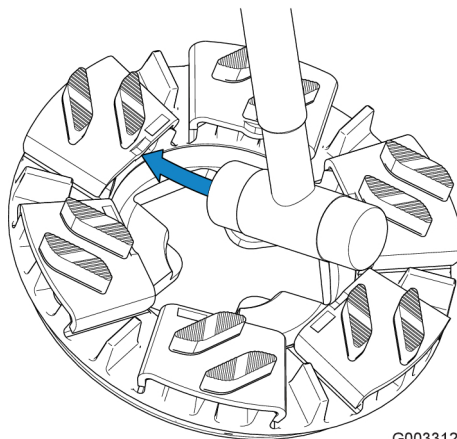

G003312

When changing the grinding tool, loosen it by giving it a few light taps with a hammer so the locking mechanism releases. Then draw the tool up out of the guide slot.

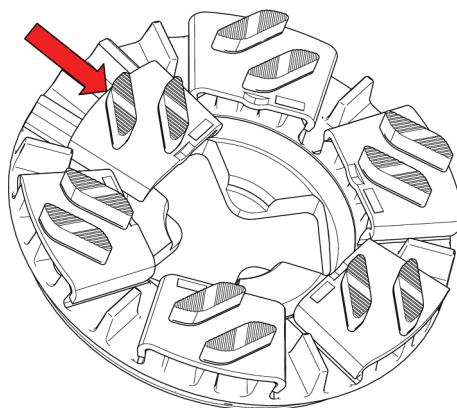

G003310

6 Grinding

Connect a dust extractor to the machine. For available models of dust extractors, go to HTC's website www.htc-floorsystems.com for more information.

Place the handle to the working position, see page 32.



WARNING

Risk for personal injury.

Do not let the cable come into contact with the rotating tools.



NOTE

Inspect the floor carefully and remove any objects sticking up, such as, for example, reinforcement rods or bolts, and any debris that could get stuck in the machine or be thrown out.

6.1 Manoeuvring via the Control Panel

During manual grinding, the machine is run forwards across the floor surface and the processing is controlled via the control panel.

For description of the control panel, see Description of Controls – Control Panel (HMI), see Description of Controls – Control Panel (HMI) page 25.

6.1.1 Manual Driving



G003372

Make sure the emergency stop switch (1) is not activated. If not, turn clockwise according to arrows on the switch.

Press the button *on/off* (2).

Start the dust extractor, if dry grinding is to be done.

Choose direction of rotation (3).

Set the speed for the grinding discs using the knob (4).

Start the grinding by pressing on (5).

When the machine is not in use, press on/off for 3 seconds, to switch the machine off.

6.1.2 Emergency Stop Switch

The emergency stop switch should only be used in an emergency, because it shortens the service life of the machine's electrical components.

When the emergency stop switch is pressed, the power to all electrical moving parts on the machine is turned off. Reset by turning the switch clockwise. The machine can then be restarted.

6.2 Making Operation Easier



WARNING

Risk for personal injury.

Do not let the cable come into contact with the rotating tools.

In order to keep the suction hose for the dust extractor and the power cable out of the working area and/or path of the machine, the hose and cable can be arranged as shown in the picture below.

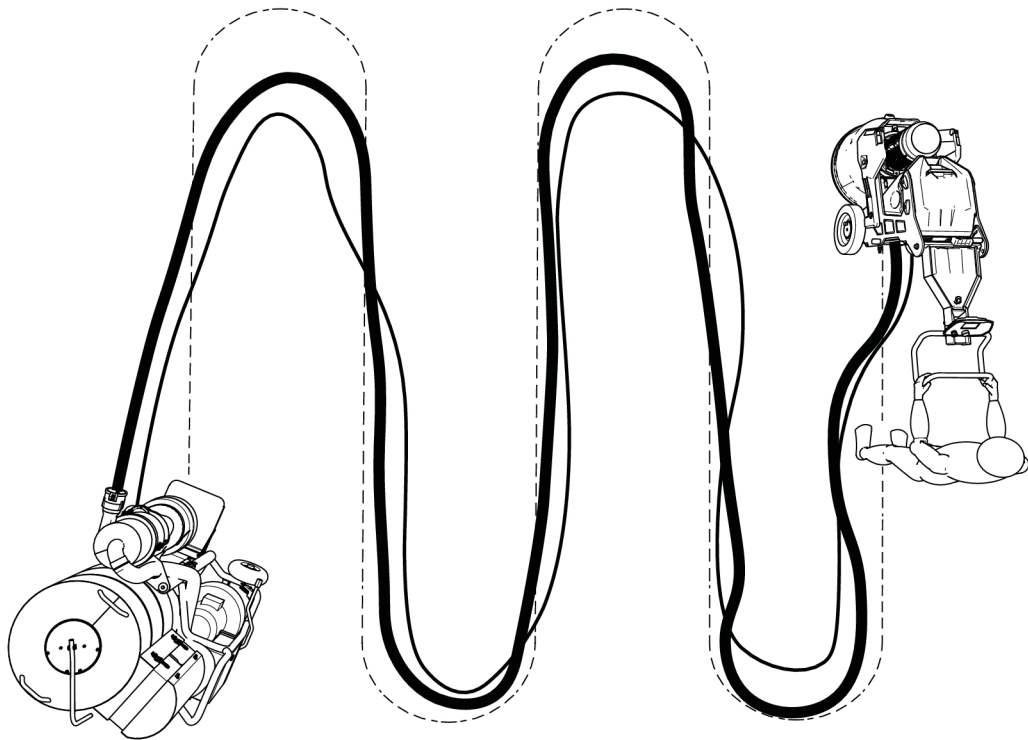

G003145



TIP

By arranging the hose and cable as shown in the picture, you avoid disruptive stoppages caused by having to re-position the cable and hose.

7 Accessories

7.1 Radio package

7.1.1 Description of Controls – Remote Control

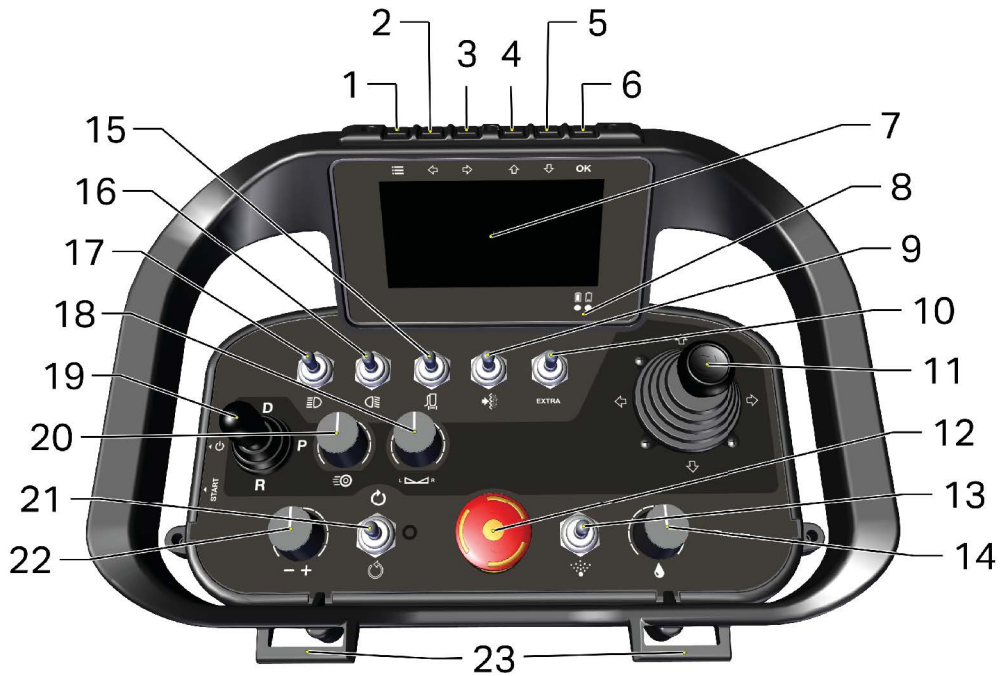

G003362

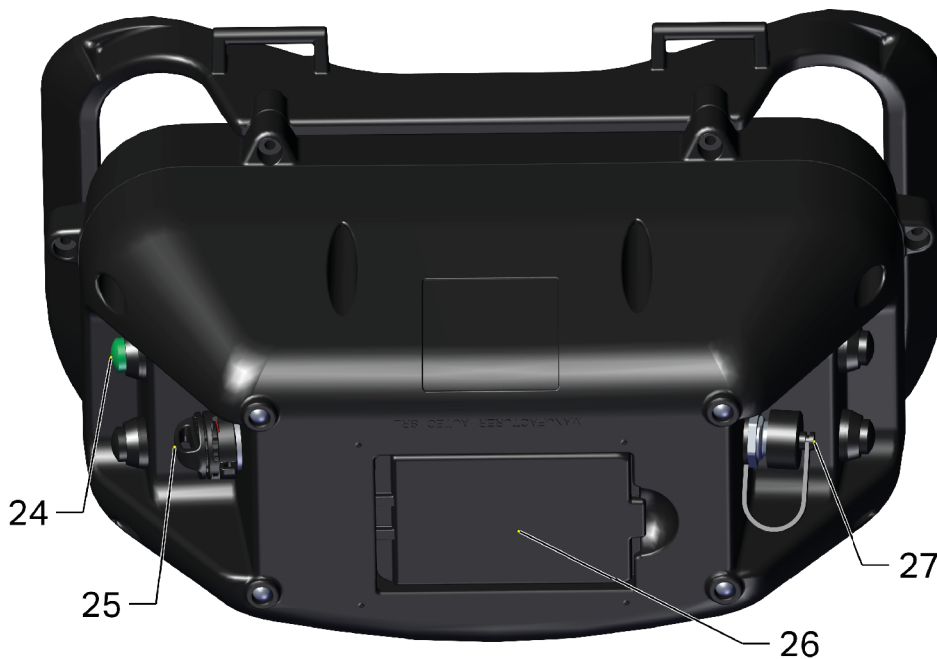

G003363

No.	Function	Description
1	Menu Buttons	Future Functions
2		Right / Left – Menu navigation as well as changing the operation gauge.
3		Right / Left – Menu navigation as well as changing the screensaver.
4		
5		Future Functions
6		
7	Display	See Information Panel page 27 .
8	Green LED	Is not lit when the unit is switched off.
		Flashes rapidly when the unit is in operation but does not have radio link.
		Flashes slowly when the unit is in operation and has radio communication.
	Red LED	Is not lit where there isn't a fault on the unit.
		It is lit when the emergency stop is depressed, driving control or grinding direction are in the wrong position. Flashes when the battery level is low.
9	Vacuum Clean Control	Future Options.
10	EXTRA	On/Off.
11	Joystick	Steering right and left as well as control of speed and direction.
12	EMERGENCY STOP	See Emergency Stop Switch page 39 .
13	Mist on/off	On/Off.
14	Water Supply	On/Off as well as adjustment of water quantity.
15	Vacuum Clean Control	Future Options.
16	Lighting rear	Accessory.
17	Lighting front	Accessory.
18	Offset (L - R)	Adjust left or right to compensate drift.
19	Driving Control	Control for driving forwards D , backwards R or parking brake P .
20	Walking Speed	Adjustment of the Propulsion Speed.
21	Grinding Direction	Control for grinding: Grinding clockwise, grinding off, grinding anticlockwise. For grinding anticlockwise, the control must be lifted to get it in position.

No.	Function	Description
22	Grinding Speed	Adjustment of the Grinding Speed
23	Hanging Bracket	For belt or shoulder hook.
24	Radio Communication	Start radio communication.
25	S-key	Radio Off/On. As well as key code for the radio.
26	Battery	For charging see: Battery Charging page 45.
27	Socket Cable Control	Cable control in environments where the radio control is not an alternative.

7.1.2 Radio Receiver

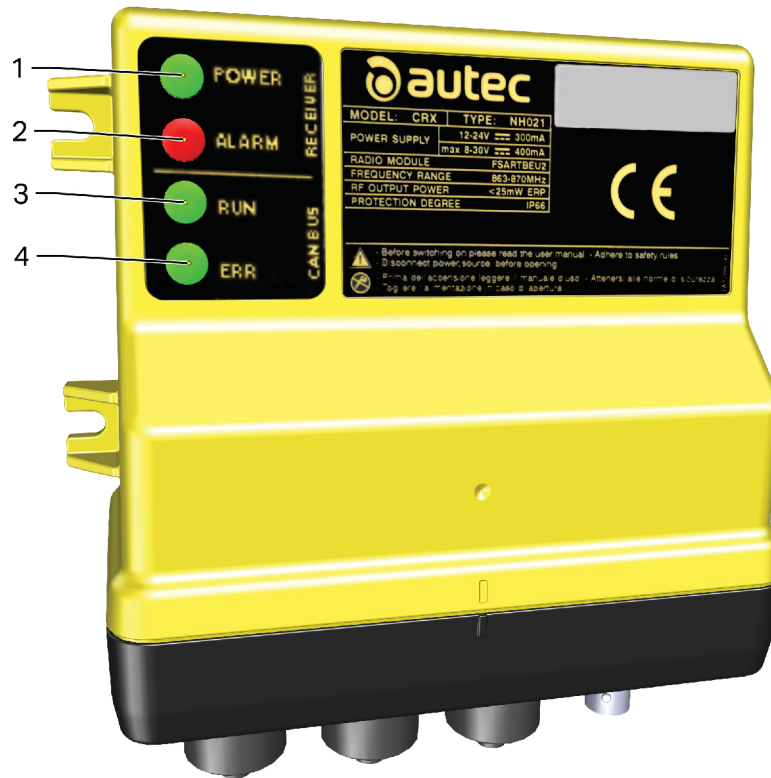

G003424

No.	LED	Lamp	Explanation
1	POWER	Is not lit	The receiver is not powered up.
		Lit	The receiver is powered up but does not have radio link.
		Flashes	The receiver is powered up and has radio link.
2	ALARM	Is not lit	The receiver is working correctly.
		Lit	Not working correctly.
		Flashes	Fault in emergency stop loop.
3	RUN	Is not lit	CAN communication is inactive.
		Lit	The receiver is not transmitting CAN bus commands.
		Flashes	The receiver has contact with the CAN bus network.
4	ERR	Is not lit	CAN bus is OK.
		Lit	CAN bus cannot contact CAN bus controller.
		Flashes	CAN bus is not working.

7.1.3 Charging

Machine Battery

If the battery disconnecter is closed (turned clockwise), the machine battery is charged.

The battery disconnecter should be closed when the machine is propelled using the remote control.

The battery disconnecter can be left closed when the machine is connected to the mains.

When the machine is not in use as well as during transport and storage, the battery disconnecter should be open.

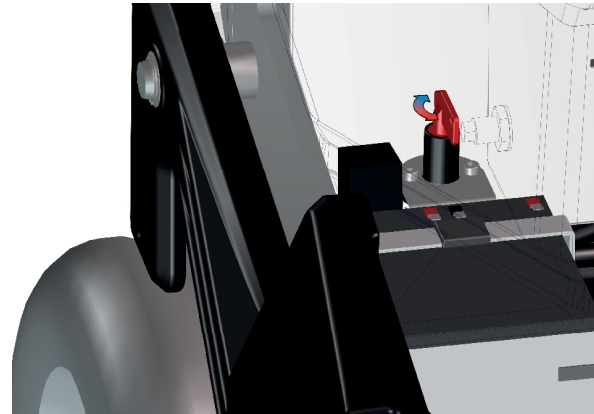

G003306

Radio Battery

The remote control's battery is charged in the battery charger when the machine is connected to the mains electric and also by the machine batteries.

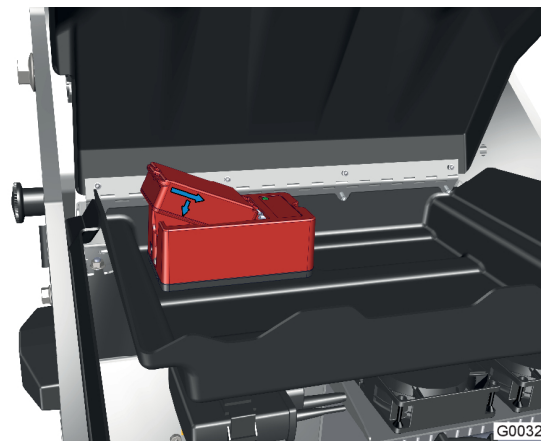

G003220

7.1.4 Operation

During radio control, the machine is manoeuvred via the remote control. For description of the remote control, see Description of Controls – Remote Control page 41.

When driving via the radio control, the machine is driven forwards with the help of the drive motors. From a work environment perspective, driving via the remote control is recommended.

Check that the wheel lock is disconnected before driving, see Locking the Wheels page 46.



WARNING

Risk for personal injury and mechanical damage.

Always keep the machine under supervision.

7.1.5 Locking the Wheels

Machines with radio control are equipped with a locking mechanism on each wheel. Wheel locking is used to lock and release the machine's wheels from their drive motors. In the locked position, the drive motors are connected to the wheels, this means that the machine can only be moved by using the drive motors via the operating panel or the remote control.

Release the wheels by pulling the locking pin straight out. Turn the locking pin 90 degrees and release it for the secured position.

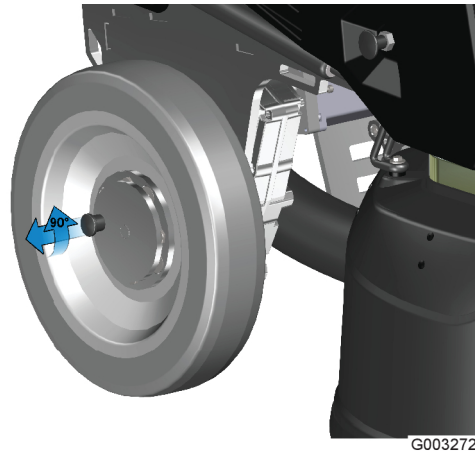

7.2 Radio Control

Lock/Release Wheel Locking

See Locking the Wheels page [46](#).

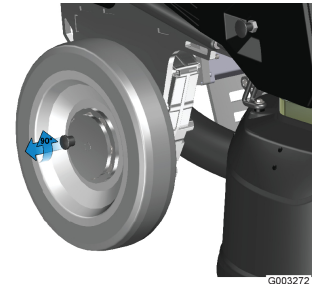

G003272

Battery Disconnecter

Switch on the battery disconnecter, see Charging page [45](#).

Remote Control

Ensure that the emergency stop switch (5) is disconnected as well as that the D-P-R control is in position P and the grinding switch is in position 0.

Turn the button *On/Off* (6) and wait for the display on the remote control to start up.

Check the battery level (7) by the display. In the case of low battery level, change battery. The battery is charged in the machine, see Storage compartment page [22](#)



G003240

Control Panel

Press the button for radio communication (1) on the control panel.

The lamp by the button (2) and the symbol on the display (3) on the control panel lights up.

Remote Control

Press the button for radio communication (8), a contact is now created between the remote control and the machine.

When the radio communication is created, the flashing frequency on LED (7) increases to 1/sec.

The machine is now in radio mode and, on the control panel, only the emergency stop switch (4) and the radio button (1) function.



G003237

Grinding

Set the grinding speed using the knob (10). The set value can be seen on the display.

Set the propulsion speed using the knob (11). The set value can be seen on the display.

Choose direction of rotation (12) for grinding. The machine starts grinding.

Select driving direction with the lever FWD/REV (13).

Control the speed (15) as needed. Can increase 2x and change direction at the same speed as max.

Adjust the offset for grinding using the knob (14) as needed.



7.3 GPS Tracker

7.3.1 Start Up

- 1 Start up outdoors so the GPS tracker has free sight for positioning.
- 2 Start the grinding machine with the *On/Off* button.
- 3 Remove the GPS tracker (1) from the holder and push in the voltage cable (2) at the same time as the cover comes loose (3).
- 4 Start the GPS tracker by moving the power switch (4) on the GPS tracker to position 1. Wait until the green diode (6) lights up. Start up can take up to 30 seconds.
- 5 Replace the cover (3) making sure at the same time that it seals.
- 6 Replace the GPS tracker in the holder on the grinding machine. Make sure that the cabling is not lying against a cooling flange or fan.

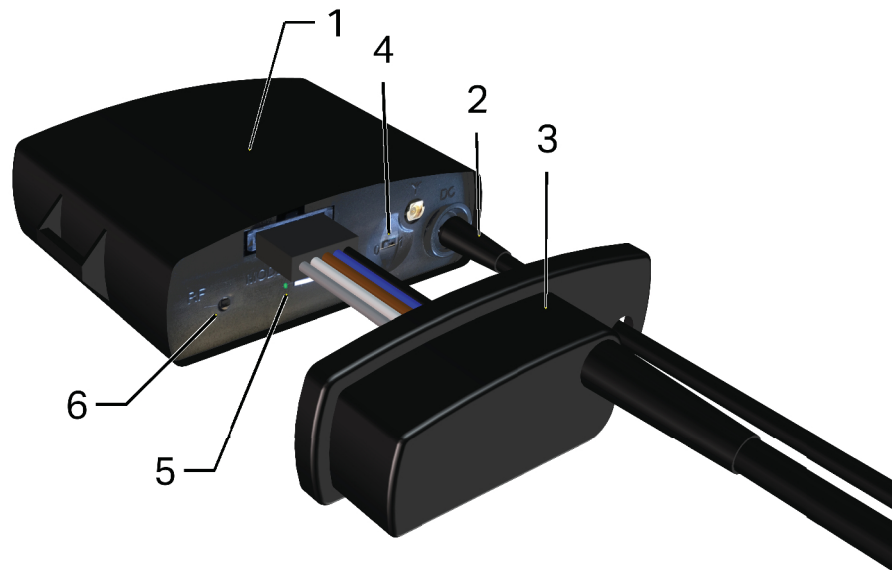

- 7 The GPS tracker searches for its position for approx. 2 minutes. This is **not** indicated by any diode.
- 8 Ring the GPS tracker's mobile number (see enclosed envelope) using any mobile phone. After a couple of signals, the call is disconnected and within a few minutes you receive a text message with date, time (GMT), position and a link to a map where the position of the GPS tracker is marked (needs Internet connection).
- 9 Charge the GPS tracker's internal battery by keeping the grinding machine connected to the mains electric for at least 8 h.

7.3.2 Registration



NOTE

Until the GPS tracker is registered, alarm functions cannot be activated and anybody can trace the position of the GPS tracker.



NOTE

A SIM card with SEK 100 from Telenor is enclosed. In countries outside Sweden, it may be easiest and simplest to acquire a SIM card from a local operator to reduce costs and to simplify handling.

Register your GPS tracker on <https://db.redknows.com/MiniFinder/default.php>.

The following information should be registered:

- The mobile number that will have access to the GPS tracker.
- Size of Geofence alarm.
- Sensitivity of the Vibration Sensor.
- The awake time of the GPS (how frequently the position will be checked).
- The unit in which the speed will be given.
- Positions in text message on map on mobile or long & lat.
- Activate the alarm function so the GPS gives an alarm when the voltage to which it is connected
 - is less than a selected level.
 - Activates an alarm on loss of external voltage.

7.3.3 Use

The following functionality is obtained with the GPS tracker.

- Locks the grinding machine for unauthorised users (same as code alarm on screen).
- Traces the grinding machine, obtains the machine's position.
- Vibration alarm, activated if the machine is disturbed.
- Geofence alarm, activated if the machine moves outside a defined area.
- Voltage alarm, gives an alarm if the machine's battery is less than 24 V, disconnected or if the GPS tracker's internal battery level is <20%.

- SOS, signal sent to defined telephone number.

All commands can be given using both the remote control and via text message, however, with one large difference.

When the remote control is used to activate Geofence alarm or sensor alarm, the machine is locked. The machine is unlocked using the remote control's standby or with PIN code (see machine manual).

Alarm is given via text message to the mobile numbers that are entered on the GPS tracker's website. For further information, consult the GPS tracker manual.

7.3.4 GSM card

The GPS tracker communicates via GSM and requires a SIM card to work. The SIM card enclosed in the packaging, when you buy the alarm in Sweden, is prepared so you can start your alarm at once.

If you choose to use another SIM card than that enclosed on purchase, remember to adapt the card as follows:

- The SIM card must have number presentation.
- Mobile answering machine (voice mail) must be **switched off**.
- The SIM card must **not** have a PIN code.

Most SIM cards work excellently with the GPS tracker, except for dedicated 3G operators. With prepaid calling cards you avoid fixed monthly fees, but a SIM card connected to a subscriptions is just as good.

When buying a SIM card, check that it has the right prerequisites by placing it in a mobile phone.

- Deactivating the PIN code is usually done from the settings in the telephone's menu. Contact your telephone operator if you need help.
- You can see if the card has number presentation and mobile answering machine by calling the number from another telephone – check if the number is presented in the display and if the mobile answering machine is activated.

7.3.5 Remote Control

Do as follows:

- 1 Check that the GPS tracker has started (the power switch is in position 1).
- 2 Press the remote control learning button (6). A green LED (RF LED) next to the remote control learning button lights up.
- 3 While the green RF LED is still lit, press any button on the remote control. The RF LED goes off and on to confirm that the pairing succeeded.
- 4 Wait until the green RF LED goes out.
- 5 The pairing is now completed and the remote control can be used.

Test that the pairing succeeded by pressing any button on the remote control, a green LED adjoining the text *RF* on the GPS tracker should light up and go out when any button on the remote control is pressed.

Teaching More than One Remote Control

While the RF LED is lit according to step 3 above, press any button on all remote controls that are to be paired with the GPS tracker. Check that the RF LED goes out and lights up to confirm the pairing when the button on the remote control is pressed in.

7.4 Water package

7.4.1 Mist Cooler System

Machines from HTC can be equipped with a Mist Cooler system for effective cooling of the grinding tools. The Mist Cooler System can be offered as a retrofit.

The Mist Cooler System creates a very finely divided water mist that is distributed on the floor surface through a nozzle. The system is used to obtain a better performance during grinding, while it is possible to grind dry and use a standard dust extractor for the dust. This cools the tools and makes grinding more effective. The Mist Cooler System reduces the risk of the diamond tools "glazing over".

The system uses the water in the tank. When the water level is low, the mist symbol changes colour to yellow.

Grinding

Attach the appropriate tool to the machine.
 Set the handle to the working position.
 Fill the tank with cold water.

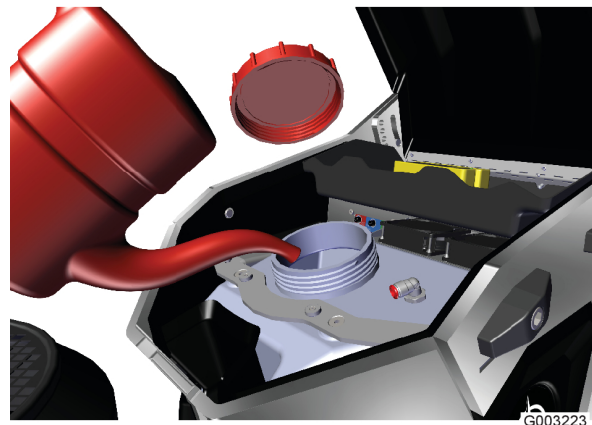

G003223

Start the Mist Cooler System by pressing the button on the control panel. When the system is active, the symbol on the display for the Mist Cooler System is lit.

When grinding is finished, the Mist Cooler System also switches off. If the Mist Cooler System is still active, this is indicated by a flashing symbol. Press again to activate.



G003252

Switch off the Mist Cooler System by pressing the same button once grinding is finished.

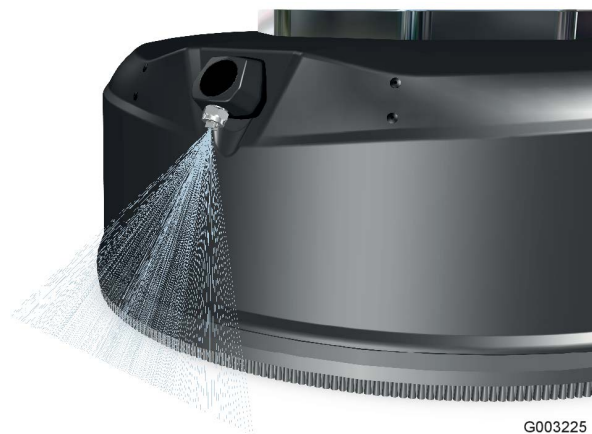

G003225

7.4.2 Wet grinding



NOTE

Make sure the water supply is only on during grinding. Always use liquid suction when wet grinding.

Wet grinding with water is used when grinding difficult to grind floors. It is also used to obtain a greater performance or lower temperature during grinding.

Grinding

Set the handle to the working position. See page 32.

Connect the water using the quick release coupling on the rear of the machine. For pressure and maximum flows, see Technical Data page 63.

An electrically controlled proportional valve controls the water flow.



G003228

Start the water flow by pressing the button on the control panel. Increase and decrease the water flow using + and - respectively.



G003253

The water is distributed via slits in the hose under the cover.

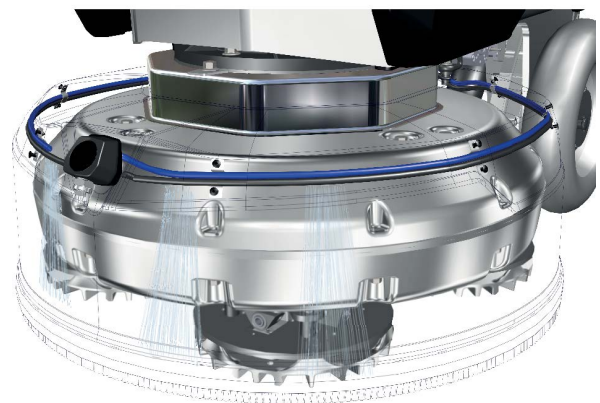

G003229

8 Maintenance and repair

8.1 General



WARNING

Moving parts. High noise level.

Risk for personal injury.

Always use the recommended personal protective equipment.



WARNING

Electrical current.

Risk for personal injury and mechanical damage.

Disconnect the power prior to cleaning, maintenance, change of tools and repair.

8.2 Cleaning



NOTE

Damage due to damp.

Risk for mechanical damage.

During cleaning, only use cold water without chemicals.

Only use high-pressure washer on grinding head.

- Always clean the machine after use. Only use high-pressure washer on grinding head and hose and sponge on the rest of the machine.
- Vacuum clean the electrical cabinet, cooling fan and cooling flange.

8.3 Prior to each new grinding process

- Check the tool holder and grinding holder to ensure that no damage or cracks have arisen. Replace parts, if there is any damage.

8.4 Daily

- Check the emergency stop function.
- Check the radio's emergency stop function.
- Check for wear to the grinding tools – abnormal or uneven wear may indicate a damaged grinding holder.
- Check the tool holder and grinding holder to ensure that no damage has arisen. Replace the parts, if there is any damage.
- Check the connection of hose and cables. Adjust if necessary.

8.5 Every week

- Clean machine and remote control.
- Check the handle's three different locking functions. Replace the bushes, if necessary.
- Check the locking function of the weights and the function of the positioning blocks, replace if necessary.
- Check the grinding holders.
- Check warning decal.
- Check the fastening between chassis and grinding head – gap, wear, dry cracks. Replace the bushes, if necessary.
- Check the grinding cover – seal, wear, cracks, brush list, extraction, hoses, couplings.
- Electrical cabinet – check seals.
- Electrical cables – check wear and attachment.
- Check the radio's rubber bellows on the joystick and switches. Replace, if necessary.

8.6 Repairs

All repairs that may need to be performed must be done by one of the HTC authorised service centres. Contact your retailer if your machine requires servicing. For contact information, see the start of the manual.

8.7 Spare parts

To ensure rapid delivery of spare parts, always specify the model, the machine's serial number and the spare part number when ordering.

Information on the model and serial number can be found on the machine's name plate.

Information on spare part numbers can be found in the machine's spare parts list, which is available to read or print out from the enclosed digital media. If you have any questions, please contact your nearest HTC retailer.

Only original tools and spare parts from HTC may be used. Otherwise, the warranty will be invalid.

8.8 Warranty

In order for the warranty to be valid, only original HTC parts should be used.

9 Troubleshooting

9.1 General

This chapter describes faults that may occur and how to deal with these faults. If the faults cannot be dealt with, or if there are other faults, contact your nearest retailer. For contact information, see the start of the manual.

Fault description	Cause	Instruction user
Fault code is shown in HMI.	One of the machine's alarm systems has been activated.	For more information see Warnings and Error Messages.
The machine loses contact with other units.	The CAN bus signal is broken.	Check cable connections on the connection panel.

9.2 The machine will not start

Error source	Cause	Instruction user
Electrical supply	Fault on supply, e.g. fuses, earth fault breakers or connecting cables	Check correct voltage on incoming phase/phases.
Power supply	Power supply indication is not lit	Check miniature circuit breaker F1.
Mainboard	Main circuit board is not lit	Check fuse.
Fuse	Standby LED on the control panel Panel is not lit	Check fuse F2 and F8.

9.3 Fuse or earth fault breaker trip frequently

Fault description	Cause	Instruction user
Earth fault breaker trips.	EMC filter, cabling or converter	Too high a leakage current/earth fault.
Fuse trips.	Too high a load or too small fuses	Check size of fuses and inertia.
		Reduce the machine's load by reducing the grinding pressure, lower the revs per minute or by changing tool. See the machine's power meter.

9.4 The machine cannot cope

Fault description	Cause	Instruction user
The machine cannot cope	Too high a load	Reduce the grinding pressure.
		If the machine runs at high speed, lower the revs per minute so the machine becomes stronger. See meter for available power.
		Voltage drop, check the voltage meter during grinding.
		Too sticky a coating on the surface being processed.
		Run half of the machine on the surface to be cleaned and half on the clean surface. This removes any residue from the tools.
		Check the tools. Ensure that the correct tools are used, that they are in working order and that they are correctly fitted.

9.5 Warnings and Error Messages







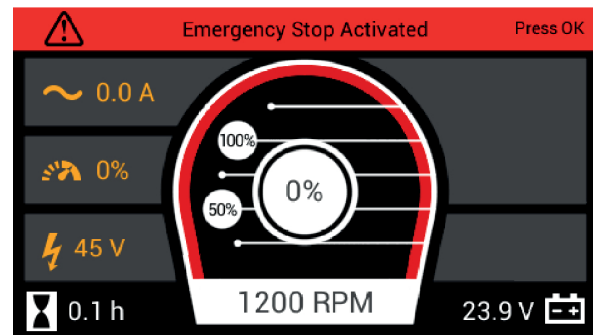

9.5.1 Warnings

The error messages and warnings are shown on the display on the machine and/or remote control. A warning message is displayed in yellow on the display, the machine can still be used. If the warning is known, the field shows a warning symbol as well as a description for the specific warning. Press OK to erase the field. A small warning symbol will continue to be visible in the symbol field as long as the warning is active. The warning is registered in the machine's log.











An error message is displayed in red on the display, the machine stops. If the error is known, the field shows a warning symbol as well as a description for the specific error. Press *OK* to attempt to reset the error. The error is registered in the machine's log.







G003286

Symbol	Warning	Fault description	Action
	CONTROL VOLTAGE LOW	Low control voltage.	Check PSU. Check battery voltage.
	GENERIC INVERTER WARNING (error code)	Converter indicates error.	Go to the HTC Support website.
	HEATSINK TEMPERATURE HIGH	Frequency converter overheats.	Check the function of the fans. Clean fans/cooling flange. Check voltage level during operation. Reduce the grinding power.
	MOTOR OVERLOAD	Grinding motor overloaded. Overload meter exceeds 90%.	Reduce the motor's load, see meter for motor current.
	MOTOR TEMPERATURE HIGH	Grinding motor overheats.	Check the motor's cooling fan. Reduce the motor's load, see meter for motor current.
	POWER UNIT TEMPERATURE HIGH	High temperature in electrical cabinet.	Clean fans and cooling flange. Check that the fans are rotating (rotating during grinding and 1 min after finished grinding as well as when needed). Let the machine cool down.
	SERVICE	Machine service.	Book service at Authorised Workshop.
	WATER LEVEL LOW	Low water level in tank.	Top up water. Check level sensor.
	VOLTAGE LOW	Low input voltage to machine.	Check voltage level during operation. Check cable area. Check electrical supply.

9.5.2 Error Messages

Symbol	Error Message	Fault description	Action
	CANBUS ERROR	Error on CAN bus.	Check cabling. Check units connected to HMI.
	EMERGENCY STOP ACTIVATED	Emergency stop activated.	Reset emergency stop. Check the remote control and reconnect radio with the connection button. See Radio Control Radio Control page 0
	GENERIC INVERTOR ERROR	Generic error converter, radio, left/right drive motor.	Go to the HTC Support website.
	GENERIC..... ERROR (error code)	Generic error converter, radio, left/right drive motor.	Go to the HTC Support website.
	HEATSINK TEMPERATURE HIGH	Cooling flange for frequency converter is overheated.	Let the frequency converter cool down.
	INVERTER OVERLOAD	The converter is overloaded.	Let the machine cool down.
	LEFT DRIVE MOTOR VOLTAGE LOW / RIGHT DRIVE MOTOR VOLTAGE LOW	Low voltage left drive motor.	Check control voltage. Check battery voltage. Check cabling to drive motors. Check voltage on relay outputs.
	MOTOR NOT CONNECTED	Break in grinding motor/grinding motor cabling.	Check grinding motor cabling. Check measure grinding motor.
	MOTOR OVERHEAT	Grinding motor is overheated.	Let the motor cool down.
	MOTOR OVERLOAD	Grinding motor becomes overloaded. Overload meter up to 100%.	Let the machine cool down.
	MOTOR SHORT CIRCUIT	Grinding motor short-circuited.	Check grinding motor cabling. Insulation measure grinding motor.

Symbol	Error Message	Fault description	Action
	OVERVOLTAGE	Input voltage too high.	Error on incoming supply.
	PHASE LOSS	Phase error incoming supply.	Incoming supply has lost one or more phases. Check incoming supply.
	RADIO VOLTAGE LOW	Low voltage radio receiver.	Check control voltage. Check battery voltage. Check cabling to radio receiver.
	UNDERVOLTAGE	Low voltage.	Check cable area and cable length. Error on incoming supply. Emergency stop activated.

10 Technical Data

	HTC T6	HTC T6	HTC T6	HTC T6
Output	6 kW / 8 hp	7.5 kW / 10 hp		
Current	50 A	30 A	15 A	
Frequency	50-60 Hz			
Voltage	1x200-240 V +-10%	3x200-240 V +-10%	3x380-415 V +-10%	3x440-480 V +-10%
Control voltage	24 V			
Total machine weight	384 kg / 846 lbs			
Chassis weight (including weights)	229 kg / 504 lbs			
Weight, grinding head	108 kg / 238 lbs			
Weights	72 kg / 158 lbs			
Grinding diameter	600 mm / 24 inch			
Grinding pressure position 1	200 kg / 440 lbs			
Grinding pressure position 2	156 kg / 343 lbs			
Grinding pressure position 3	132 kg / 291 lbs			
Grinding pressure position 4	92 kg / 202 lbs			
RPM, grinding discs	450-1500 rpm			
Grinding discs	3 x 230 mm / 3 x 9 inch			

	HTC T6	HTC T6	HTC T6	HTC T6
Rec. minimum cable area	16 mm ² 6 AWG	6 mm ² 10 AWG		2.5 mm ² 14 AWG
Storage temp. (short term, e.g. transport)	-20 – +60 °C - 4 – +140 °F			
Working temp.	-10° – +40 °C +14 – +104 °F			
Humidity	Max. 95% but no condensation			
Sound pressure level, according to ISO 11201	82 – 88 dBA			
Sound power level, according to ISO 3744	94 – 100 dBA			
Vibrations, Floor preparation (T-Rex)	1.43 m/s ²			
Permitted daily exposure, Floor preparation (T-Rex)	> 10 h			

	HTC RT6	HTC RT6	HTC RT6	HTC RT6
Output	6 kW / 8 hp	7.5 kW / 10 hp		
Current	50 A	30 A	15 A	
Frequency	50-60Hz			
Voltage	1x200-240 V +-10%	3x200-240 V +-10%	3x380-415 V +- 10%	3x440-480 V +-10%
Control voltage	24 V			
Total machine weight	423 kg / 932 lbs			
Chassis weight (including weights)	268 kg / 590 lbs			
Weight, grinding head	108 kg / 238 lbs			
Weights	72 kg / 158 lbs			
Grinding diameter	600 mm / 24 inch			
Grinding pressure position 1	205 kg / 451 lbs			
Grinding pressure position 2	161 kg / 354 lbs			
Grinding pressure position 3	137 kg / 302 lbs			
Grinding pressure position 4	96 kg / 211 lbs			
RPM, grinding discs	450-1500 rpm			
Grinding discs	3 x 230 mm / 3 x 9 inch			
Rec. minimum cable area	16 mm ² 6 AWG	6 mm ² 10 AWG	2.5 mm ² 14 AWG	
Storage temp. (short term, e.g. transport)	-20° – +60 °C - 4 – +140 °F			

	HTC RT6	HTC RT6	HTC RT6	HTC RT6
Working temp.	-10° – +40 °C +14 – +104 °F			
Humidity	Max. 95% but no condensation			
Sound pressure level, according to ISO 11201	82 – 88 dBA			
Sound power level, according to ISO 3744	94 – 100 dBA			
Vibrations, Floor preparation (T-Rex)	1.43 m/s ²			
Permitted daily exposure, Floor preparation (T-Rex)	> 10 h			
Propulsion speed	28.5 m/min 93.5 ft/min			
Frequency is dependent on rules in different countries (transmitter/receiver)	870 MHz, 915 MHz, 447 MHz, 434 MHz, 429 MHz			

	HTC X6	HTC X6	HTC X6	HTC X6
Output	6 kW / 8 hp	7.5 kW / 10 hp		
Current	50 A	30 A	15 A	
Frequency	50-60 Hz			
Voltage	1x200-240 V +-10%	3x200-240 V +-10%	3x380-415 V +-10%	3x440-480 V +-10%
Control voltage	24 V			
Total machine weight	399 kg / 879 lbs			
Chassis weight (including weights)	229 kg / 504 lbs			
Weight, grinding head	123 kg / 271 lbs			
Weights	72 kg / 158 lbs			
Grinding diameter	600 mm / 24 inch			
Grinding pressure position 1	214 kg / 471 lbs			
Grinding pressure position 2	171 kg / 376 lbs			
Grinding pressure position 3	147 kg / 324 lbs			
Grinding pressure position 4	107 kg / 235 lbs			
RPM, grinding discs	450-1500 rpm			
Grinding discs	4 x 230 mm / 4 x 9 inch			
Rec. minimum cable area	16 mm ² 6 AWG	6 mm ² 10 AWG	2.5 mm ² 14 AWG	
Storage temp. (short term, e.g. transport)	-20° – +60 °C - 4 – +140 °F			

	HTC X6	HTC X6	HTC X6	HTC X6
Working temp.	-10° – +40 °C +14 – +104 °F			
Humidity	Max. 95% but no condensation			
Sound pressure level, according to ISO 11201	82 – 88 dBA			
Sound power level, according to ISO 3744	94 – 100 dBA			
Vibrations, Floor preparation (T-Rex)	1.62 m/s ²			
Permitted daily exposure, Floor preparation (T-Rex)	> 10 h			

	HTC RX6	HTC RX6	HTC RX6	HTC RX6
Output	6 kW / 8 hp	7.5 kW / 10 hp		
Current	50 A	30 A	15 A	
Frequency	50-60 Hz			
Voltage	1x200-240 V +-10%	3x200-240 V +-10%	3x380-415 V +-10%	3x440-480 V +-10%
Control voltage	24 V			
Total machine weight	441 kg / 972 lbs			
Chassis weight (including weights)	268 kg / 590 lbs			
Weight, grinding head	123 kg / 271 lbs			
Weights	72 kg / 158 lbs			
Grinding diameter	600 mm / 24 inch			
Grinding pressure position 1	223 kg / 491 lbs			
Grinding pressure position 2	177 kg / 390 lbs			
Grinding pressure position 3	153 kg / 337 lbs			
Grinding pressure position 4	112 kg / 246 lbs			
RPM, grinding discs	450-1500 rpm			
Grinding discs	4 x 230 mm / 4 x 9 inch			
Rec. minimum cable area	16 mm ² 6 AWG	6 mm ² 10 AWG	2.5 mm ² 14 AWG	
Storage temp. (short term, e.g. transport)	-20° – +60 °C - 4 – +140 °F			

	HTC RX6	HTC RX6	HTC RX6	HTC RX6
Working temp.	-10° – +40 °C +14 – +104 °F			
Humidity	Max. 95% but no condensation			
Sound pressure level, according to ISO 11201	82 – 88 dBA			
Sound power level, according to ISO 3744	94 – 100 dBA			
Vibrations, Floor preparation (T-Rex)	1.62 m/s ²			
Permitted daily exposure, Floor preparation (T-Rex)	> 10 h			
Propulsion speed	28.5 m/min 93.5 ft/min			
Frequency is dependent on rules in different countries (transmitter/receiver)	870 MHz, 915 MHz, 447 MHz, 434 MHz, 429 MHz			



G003416

Dimensions	H	W	L1
Grinding position	1346 mm 53 inch	657 mm 26 inch	2018 mm 79.5 inch

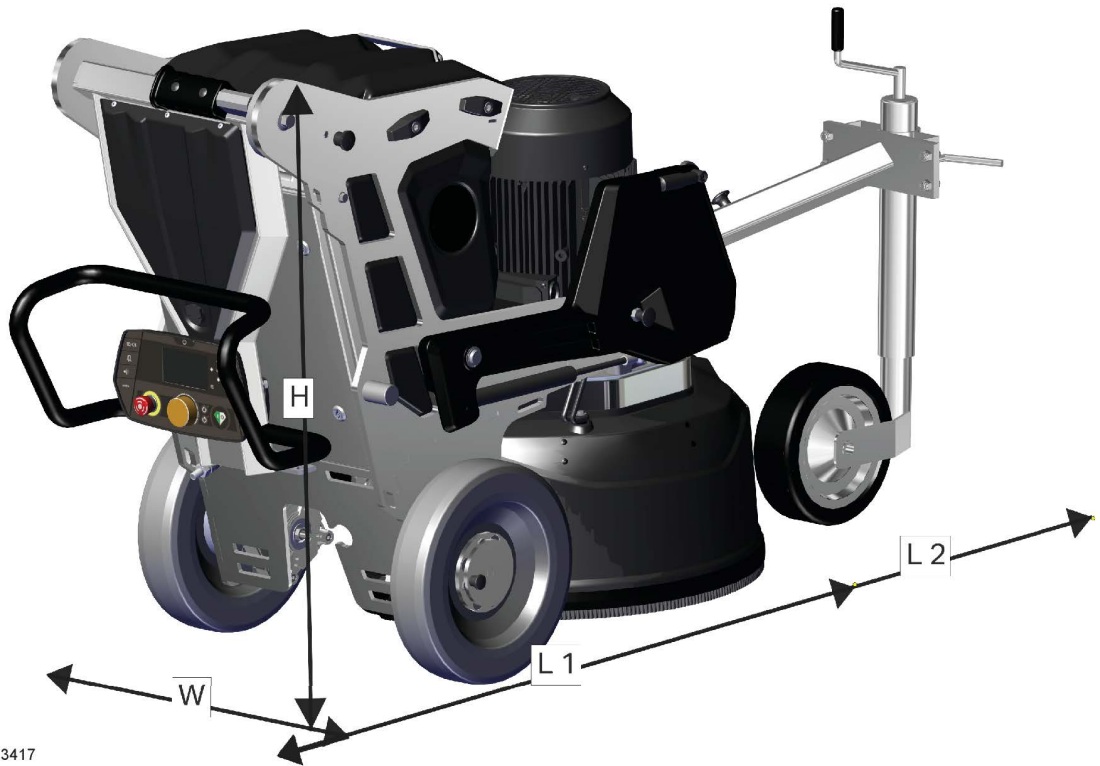

Dimensions	H	W	L1	L2
Transport position	1054 mm 41.5 inch	657 mm 26 inch	1385 mm 54.5 inch	1958 mm 77 inch

11 Environment

HTC's products are constructed mainly of recyclable metal and plastic. The main materials used are listed below.

11.1 Chassis

Machine part	Material	Waste management
Chassis	Metal	Metal recycling ¹⁾
Handle	Plastic covered steel	Metal recycling ¹⁾
Wheels	Rubber	Metal recycling / Combustible
Cover	Plastic, ABS	Combustible
Fixed parts	Metal	Metal recycling ¹⁾
Hose connections	Metal, aluminium	Metal recycling ¹⁾
Hoses	Plastic, PUR and PVC	Combustible
Support blocks	Plastic, POM	Combustible
Hose guide	Plastic, PP/PA	Combustible

¹⁾ If possible, different metals should be separated.

11.2 Grinding head

Machine part	Material	Waste management
Housing halves	Aluminium	Metal recycling ¹⁾
Grinding cover	Plastic, ABS and TPU	Plastic recycling / Combustible
Other components	Steel	Metal recycling ¹⁾

¹⁾ If possible, different metals should be separated.

11.3 Electrical system

Machine part	Material	Waste management
Control cabinet	Steel	Metal recycling ¹⁾
Cables	Copper conductors with PVC / Nylon covering	Metal recycling ¹⁾
Electrical components		Electronic waste

1) If possible, different metals should be separated.

11.4 Recycling

The machine or machine components can be returned to HTC Sweden AB.



G003127

The machine or machine components can be returned to HTC Sweden AB. For recycling and scrapping of components, see the applicable national regulations for each country. Used electrical and electronic products, including all types of batteries, are to be left at dedicated collection points for recycling (according to Directive 2012/19/EU and 2006/66/EC).

