



SPARE PARTS LIST

POWER CUTTERS

K30, 2009-05

D K30/K40

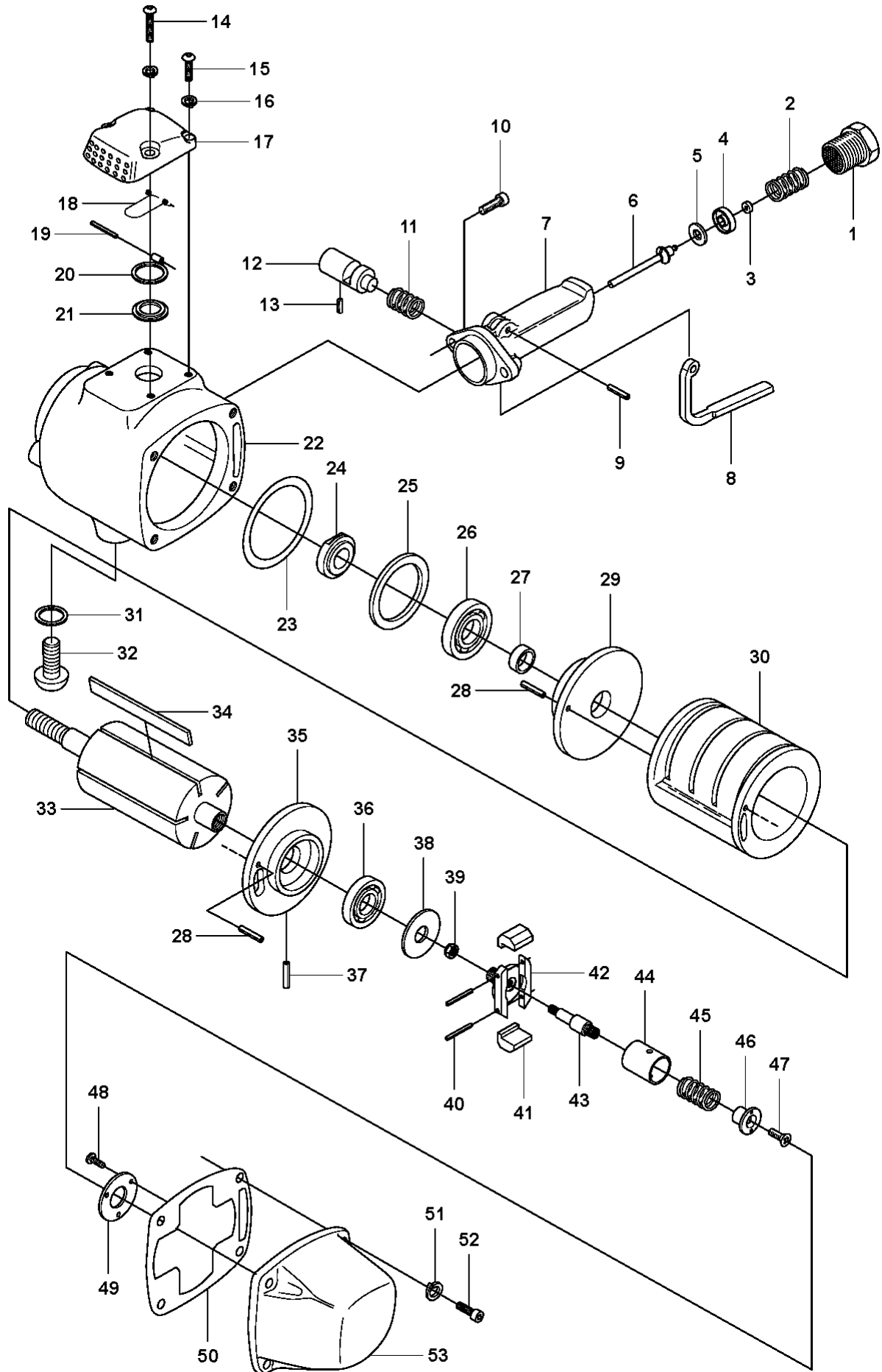

AIR MOTOR

K30, 2009-05

Ref	Part No	Description	Remark	QTY KIT
1	506 19 06-01	FITTING		1
2	506 19 29-01	SPRING		1
3	506 19 41-01	THROTTLE VALVE		1
4	506 19 27-01	WASHER		1
5	506 19 26-01	VALVE		1
6	506 19 28-01	SHAFT		1
7	506 19 08-01	HANDLE		1
8	506 19 18-01	LEVER		1
9	506 19 58-01	PIN RETAINING SCREW		1
10	544 21 84-02	SCREW ITXSCM		2
11	506 19 40-01	SPRING		1
12	506 19 39-01	KNOB		1
13	506 19 65-01	SCREW		1
14	725 52 99-05	SCREW IHSCM		2
15	725 52 95-55	SCREW IHSCM		2
16	735 21 36-01	LOCKWASHER		4
17	506 19 51-01	COVER	K40	1
18	506 19 53-01	SPRING		1
19	506 19 60-01	PIN RETAINING SCREW		1
20	506 19 54-01	HOLDER		1
21	506 19 52-01	VALVE		1
22	506 19 42-01	HOUSING	K40	1
23	506 19 49-01	ADJUSTING WASHER		1
24	506 19 47-01	ROTOR NUT		1
25	506 19 57-01	BEARING		1
26	506 19 15-01	BALL BEARING		1
27	506 19 48-01	ADJUSTING SLEEVE		1
28	506 19 61-01	PIN RETAINING SCREW		2
29	506 19 46-01	BEARING HOUSING		1
30	506 19 44-11	CYLINDER	K30	1
30	506 19 44-01	AIR CLEANER	K40	1
31	506 19 55-01	SPRING		1
32	506 19 63-01	SCREW		1
33	506 19 43-11	ROTOR	K30	1
33	506 19 43-01	ROTOR	K40	1
34	506 19 16-11	ROTOR	K30	5
34	506 19 16-02	ROTOR BLADE, SET	K40	5
35	506 19 45-01	BEARING HOUSING		1
36	503 25 00-02	BALL BEARING		1
37	506 19 62-01	PIN RETAINING SCREW		1
38	506 19 50-01	WASHER		1
39	731 23 14-05	HEXAGON NUT		1
40	506 19 59-01	PIN RETAINING SCREW		2
41	506 19 35-11	WEIGHT	K30	2
41	506 19 35-01	REGULATOR WEIGHT	K40	2
42	506 19 34-01	HOLDER		1
43	506 19 37-01	SHAFT		1
44	506 19 31-01	SLEEVE		1
45	506 19 32-11	SPRING	K30	1
45	506 19 32-01	SPRING	K40	1
46	506 19 38-01	VALVE		1
47	724 32 91-01	SCREW		1
48	723 12 89-51	SCREW SLCHM		3
49	506 19 56-01	WASHER		1
50	506 19 13-01	GASKET		1
51	735 11 53-50	SPRING WASHER		4
52	725 53 70-55	SCREW IHSCM		4
53	506 19 12-01	COVER		1

C K30/K40

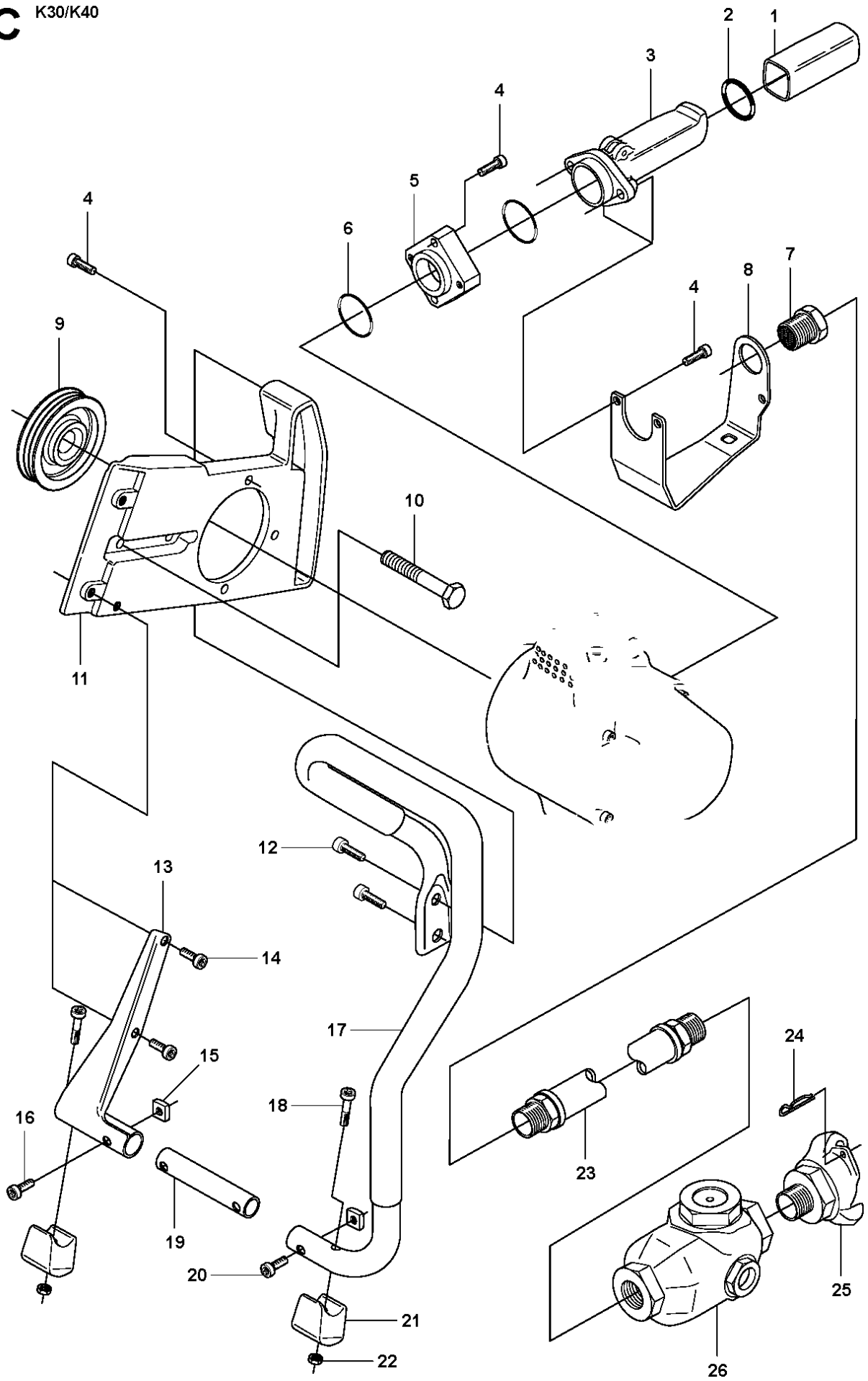

HANDLE

K30, 2009-05

Ref	Part No	Description	Remark	QTY KIT
1	506 19 17-01	GRIP		1
2	503 26 30-16	O-RING		1
3	506 19 08-01	HANDLE		1
4	544 21 84-20	SCREW ITXSCM		8
5	506 20 41-01	MANIFOLD		1
6	740 48 27-02	O-RING		2
7	506 19 06-01	FITTING		1
8	506 23 48-02	COVER		1
9	525 60 64-01	DRIVING PULLEY		1
10	506 03 32-02	SCREW		2
11	506 19 20-02	ENGINE PLATE		1
12	503 21 53-16	SCREW ITXSCM		2
13	506 14 42-02	GROUND SUPPORT		1
14	503 21 53-12	SCREW ITXSCM		2
15	503 22 65-04	SQUARE NUT		2
16	503 21 53-30	SCREW ITXSCM		1
17	506 07 26-07	FRONT HANDLE		1
18	503 21 53-41	SCREW ITXSCM	K40	2
19	506 19 23-02	SPACER		1
20	503 21 53-26	SCREW ITXSCM		1
21	506 14 43-02	GROUND SUPPORT	K40	2
22	732 21 14-01	LOCK NUT	K40	2
23	506 19 10-01	HOSE		1
24	721 68 01-51	SPRING COTTER		1
25	506 19 72-01	KLOKOPPLING 1/2"		1
26	506 19 11-01	OILER		1

A K30/K40

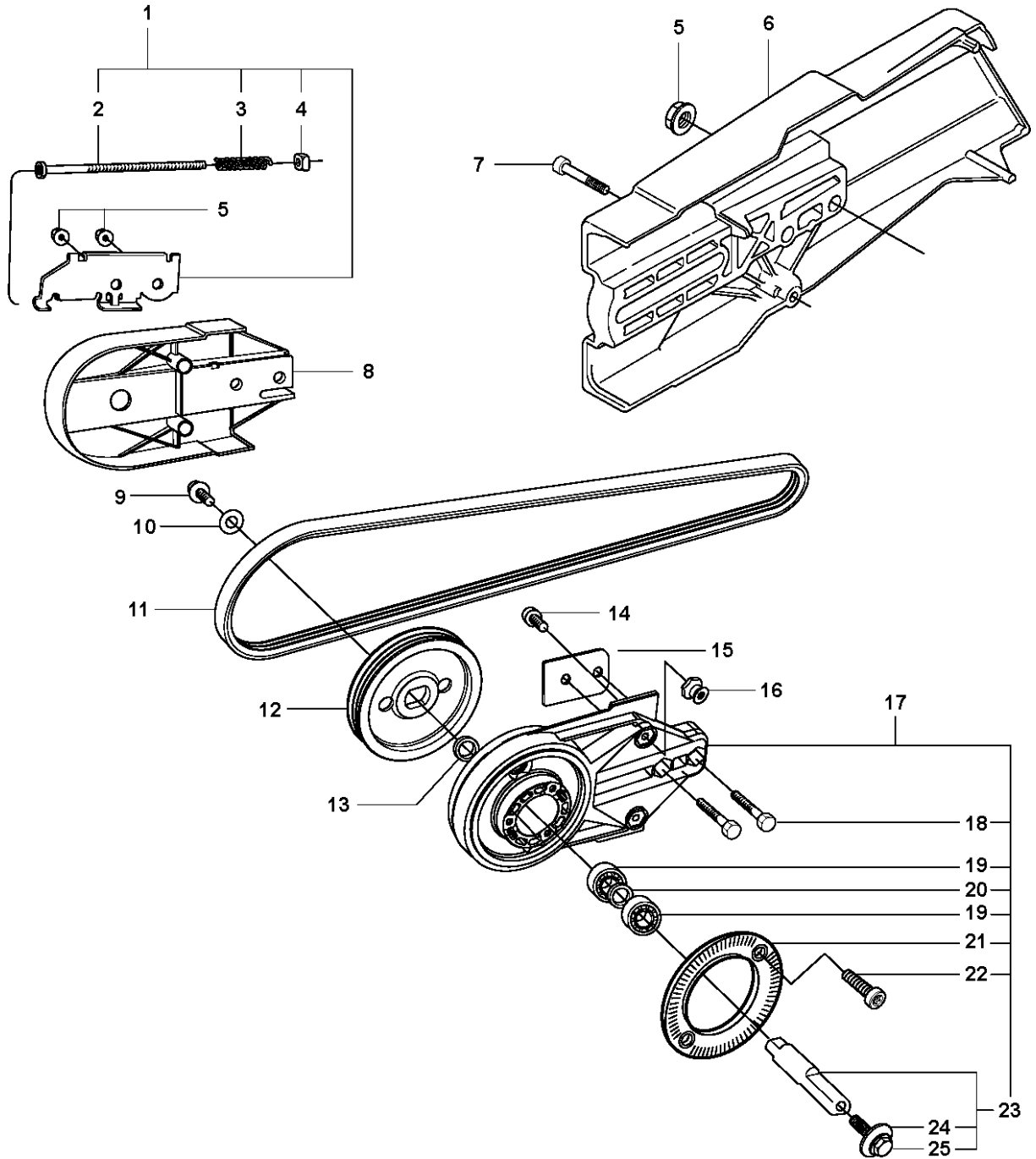

PULLEY

K30, 2009-05

Ref	Part No	Description	Remark	QTY KIT
1	506 03 06-03	BELT TENSIONER ASSY	Incl. 2 - 4	1
2	503 20 72-20	SCREW CITXSCM		1
3	506 21 95-01	COMPRESSION SPRING		1
4	503 22 66-01	SQUARE NUT		1
5	503 22 00-01	HEXAGON NUT		4
6	506 02 90-02	CUTTER ARM		1
7	503 21 53-20	SCREW ITXSCM		1
8	506 09 87-02	BELT GUARD		1
9	503 20 00-45	SCREW EHHFM		1
10	503 23 01-16	WASHER		1
11	544 97 63-03	BELT		1
12	544 98 09-01	PULLEY		1
13	503 23 01-04	WASHER		1
14	505 57 41-16	SCREW ITXSCM		1
15	525 60 65-01	SPACER		1
16	506 14 32-01	TORSION STOP		1
17	506 41 34-04	BEARING HOUSING ASSY	Incl. 18 - 23	1
18	506 03 32-02	SCREW		2
19	583 95 33-01	BALL BEARING		2
20	506 20 18-01	SPACING SLEEVE		1
21	506 28 84-01	SCREEN		1
22	503 21 53-10	SCREW ITXSCM		2
23	506 29 83-71	SHAFT	Incl. 24 - 25	1
24	506 13 95-11	WASHER		1
25	506 13 96-01	SCREW EHHFM		1
26	506 30 97-05	LABEL	Japan only	1

F K30/K40

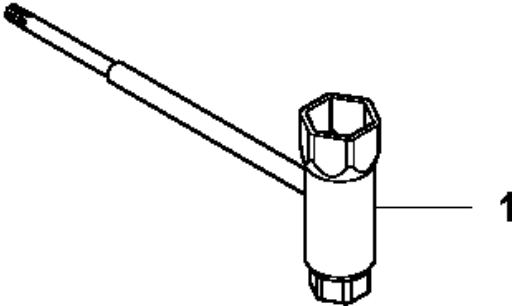

TOOLS

K30, 2009-05

Ref	Part No	Description	Remark	QTY KIT
1	506 38 26-01	TOOL		1

E K30/K40



	A (mm)	B (mm)
K30 12"	165	320
K40 14"	205	320

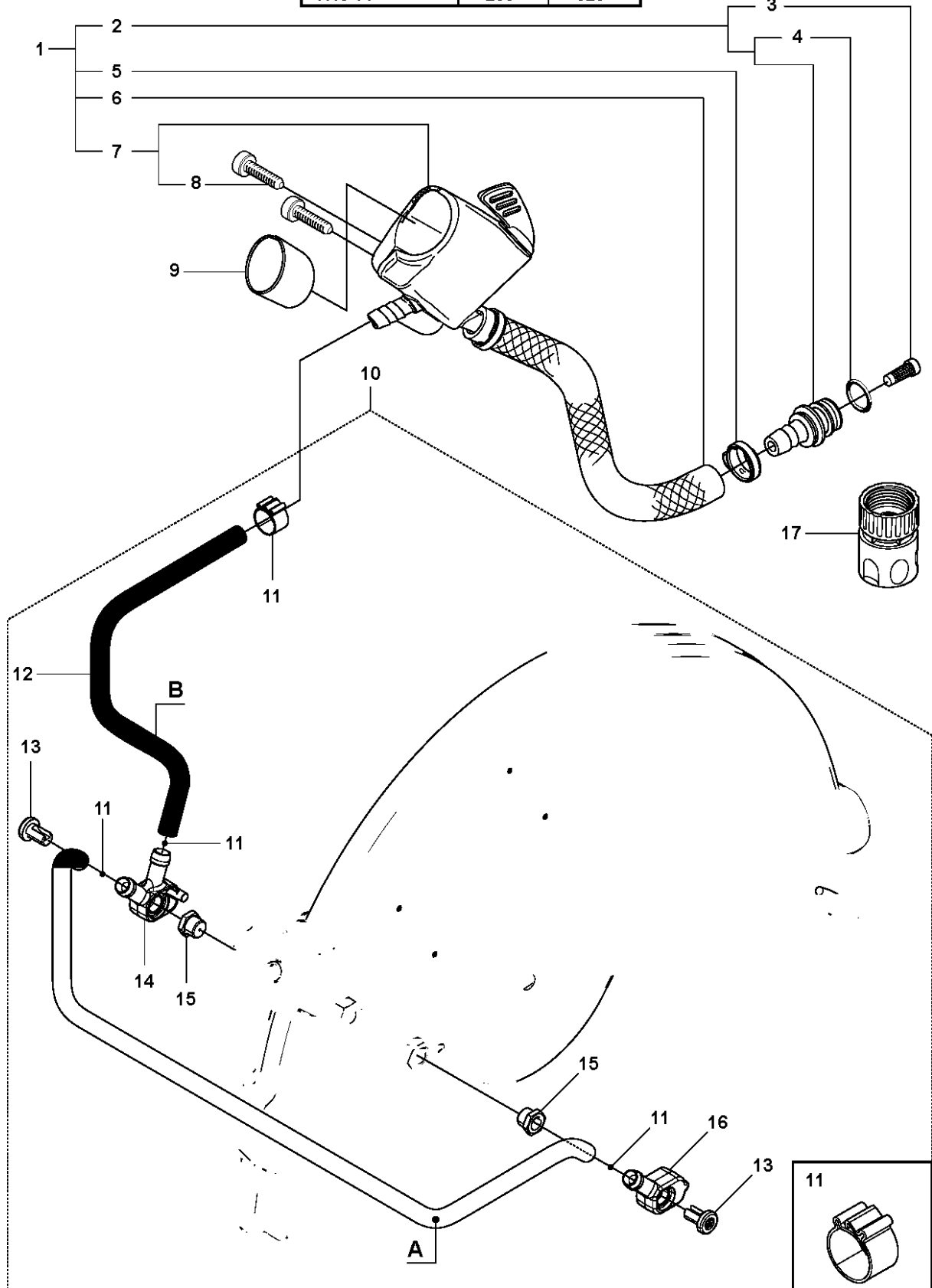

WET CUTTING KIT

K30, 2009-05

Ref	Part No	Description	Remark	QTY KIT
1	505 09 55-01	HOSE KIT	Incl. 2, 5 - 7	1
2	506 29 57-02	NIPPLE	Incl. 3, 4	1
3	506 29 88-01	FILTER		1
4	505 10 35-01	O-RING		1
5	506 49 87-02	HOSE CLAMP		2
6	506 60 75-01	HOSE		1
7	506 38 60-12	VALVE ASSY	Incl. 8	1
8	503 21 54-20	SCREW ITXSCT		2
9	544 92 68-01	INTERLAYER		1
10	505 09 54-01	HOSE KIT	Incl. 11 - 16	1
11	506 49 87-01	HOSE CLAMP		4
12	506 60 68-06	HOSE	320 mm	1
13	504 63 46-01	SCREW ITXSCM		2
14	504 63 44-01	HOUSING		1
15	504 63 42-01	NIPPLE		2
16	504 63 45-01	HOUSING		1
17	503 26 60-03	COUPLER	USA	1
17	503 26 60-04	COUPLER		1

B K30/K40

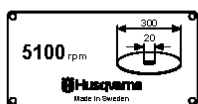
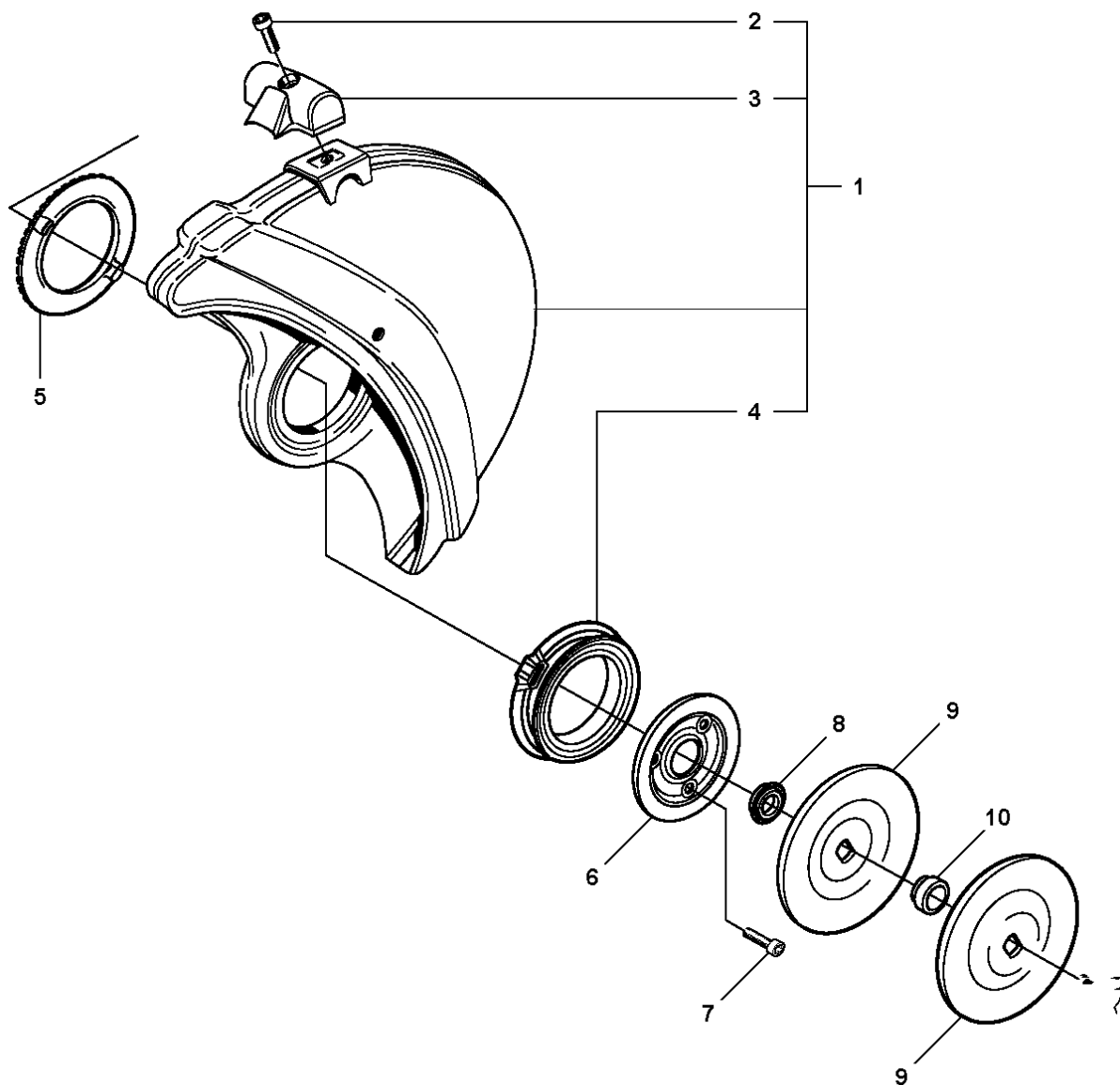

11



12



13

WHEELS & TIRES

K30, 2009-05

Ref	Part No	Description	Remark	QTY KIT
1	506 34 05-42	BLADE GUARD	"12"" , Incl. 2 - 4"	1
1	506 34 05-44	BLADE GUARD	"14"" , Incl. 2 - 4"	1
2	503 21 53-20	SCREW ITXSCM		1
3	506 34 46-02	HANDLE		1
4	506 26 63-02	LINING		1
5	506 26 64-01	SCREEN		1
6	506 26 65-01	FLANGE		1
7	505 57 41-16	SCREW ITXSCM		3
8	506 32 48-01	SUPPORT FLANGE		1
9	506 02 87-01	FLANGE WASHER	Diam 105 mm	2
10	506 37 96-20	KIT	Diam 20 mm	1
10	506 37 96-22	KIT	Diam 22,2 mm	1
10	506 37 96-25	KIT	Diam 25,4 mm	1
10	506 02 88-30	BUSHING	Diam 30,5 mm	1
11	506 28 41-04	LABEL	"12"" , Diam 1""	1
11	506 28 41-02	LABEL	"12"" , Diam 20 mm"	1
11	506 28 41-14	LABEL	"14"" , Diam 1""	1
11	506 28 41-12	LABEL	"14"" , Diam 20 mm"	1
12	506 24 34-35	LABEL	Japan only	1
13	506 24 35-25	LABEL	Japan only	1